CATALOG

SACE Tmax PV for photovoltaic applications

Adaptability, versatility and complete freedom



The SACE Tmax PV range of molded-case circuit-breakers and switch-disconnectors for photovoltaic applications offers an increasingly comprehensive, leading-edge solution that anticipates the market trends.

Table of contents

01-07 Introduction

08-25 IEC applications

26-41 UL applications

42-55 800V AC applications

56-63 Ordering codes





CHAPTER 1

Introduction

- 02-03** **Keeping ahead of the photovoltaic application trends**
- 04-05** **Value proposition**
- 06-07** **Examples of photovoltaic plants**

Keeping ahead of the photovoltaic application trends

Quality and innovation, the ability to keep up with technological developments and satisfy the changing needs of customers and the market: these, in short, are the key strengths of the **SACE Tmax PV** range of low voltage molded-case circuit-breakers and switch-disconnectors for photovoltaic applications.

The **SACE Tmax PV** range of molded-case circuit-breakers and switch-disconnectors for IEC and UL applications on both the DC and AC sides of a photovoltaic plant, expands the widely appreciated ability of the **SACE Tmax T** range to provide the most adaptable and versatile solution for every type of application. The **SACE Tmax PV** range was created with internationalization in mind. It offers design engineers, panel builders and inverter manufacturers the chance to rely on a single provider and meet the specific requirements of photovoltaic systems installed in any part of the world.

A range that keeps pace with the times. But the trend in photovoltaic systems is a growing use of configurations based on string inverters and an increase in operating voltages. The aim is to enhance energy efficiency and limit the rated currents involved, thereby reducing switchgear size, installation time and costs.

This trend is a known fact. By 2020, according to estimates, 93% of PV systems above one megawatt will function with 1500V DC rated voltage, especially in the area where UL regulations are applicable. This will help to increase the power density and significantly reduce the number of combiners, inverters and conductors required compared to the currently used 1000V DC systems.



For use in such applications, the **SACE Tmax PV** range includes a series of molded-case circuit-breakers and switch-disconnectors for PV applications up to 1500V DC that conform perfectly to UL and IEC standards. Meanwhile, the AC equipment in photovoltaic systems is also evolving at a continuous rate. The inverters used at the present time are designed to operate in coordination with 600 or 690V AC distribution systems. Since they are connected to the grid by transformers, new installations are designed by increasing the voltage values and reducing the losses, so as to create increasingly efficient systems.

This is especially the case in PV systems based on configurations with string inverters, which typically require extremely long cables. Here again, the **SACE Tmax PV** range is one step ahead of market requirements and proposes a line of circuit-breakers for alternating current with increased rated voltage values up to 800V AC.



Value proposition

Edge technologies to be a step ahead

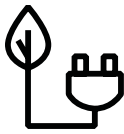

Energy efficiency

SACE Tmax PV technology is ready to boost the overall trends toward higher voltages, either in PV systems based on central inverters, where 1500V on the DC side has become a market standard, and in PV systems based on string inverters, where 800V on the AC side is the most up-to-date solution to cut down power losses. To be highlighted that SACE Tmax PV range offers the first 800V AC molded case circuit-breaker according to UL 489 Standard available in the market.



Speed up your projects

Ensuring performances at 1500V for the DC side and 800V for the AC side, SACE Tmax PV range grants shorter installation times and lower wiring costs for the most advanced photovoltaic plants architectures, with significant time savings for utilities, engineers and panel builders.

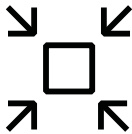

Space saving

Higher voltages running through a photovoltaic plant means a reduced number of components and easier logistics. Furthermore, SACE Tmax PV range is one of the most compact in the market and offers an integrated motorized version that squeezes the sizes to unexpected limits.



Easy to install

SACE Tmax PV range offers a complete portfolio of shared accessories, including connection jumpers as mandatory for the UL versions. The jumper kits provide simplicity of installation and maximum safety. The SACE Tmax PV range is derived from the widely known SACE Tmax T range, ensuring edge technology, top-level quality and no need to change installation practices. Furthermore, SACE Tmax PV range is perfectly integrated in the wide range of electrical and mechanical accessories already present in the SACE Tmax T range.



Global availability

Inside the Tmax PV range you find products meeting all the major worldwide Standards: IEC, UL, CCC and GB. This means that engineers, panel builders, inverter manufacturers and OEMs can find the right solution for any solar plant, wherever it will be installed around the world.

Examples of photovoltaic plants

String inverters architecture

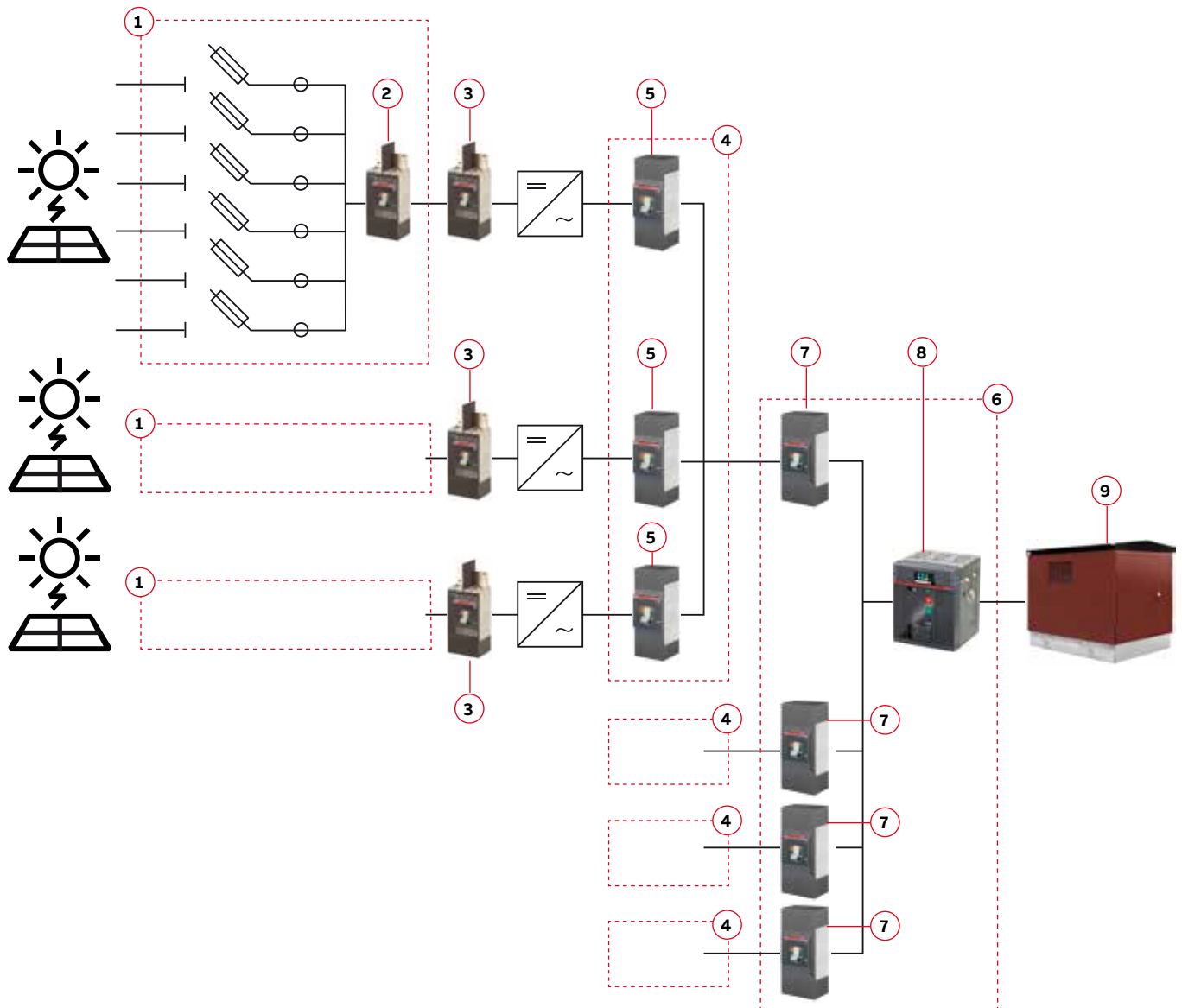

1. String Combiner
2. Molded Case Switch-Disconnecter (e.g. T4D/PV-E)
3. Molded Case Circuit-Breakers Tmax PV (e.g. T4N/PV-E)
4. AC Combiner
5. Molded Case Circuit-Breakers for AC applications (e.g. T4V-HA)
6. Switchboard / AC Recombiner
7. Molded Case Circuit-Breakers for AC applications (e.g. T5V-HA)
8. Air Circuit-Breaker Emax 2
9. MV/LV Transformer - Compact Secondary Substation

Central inverters architecture

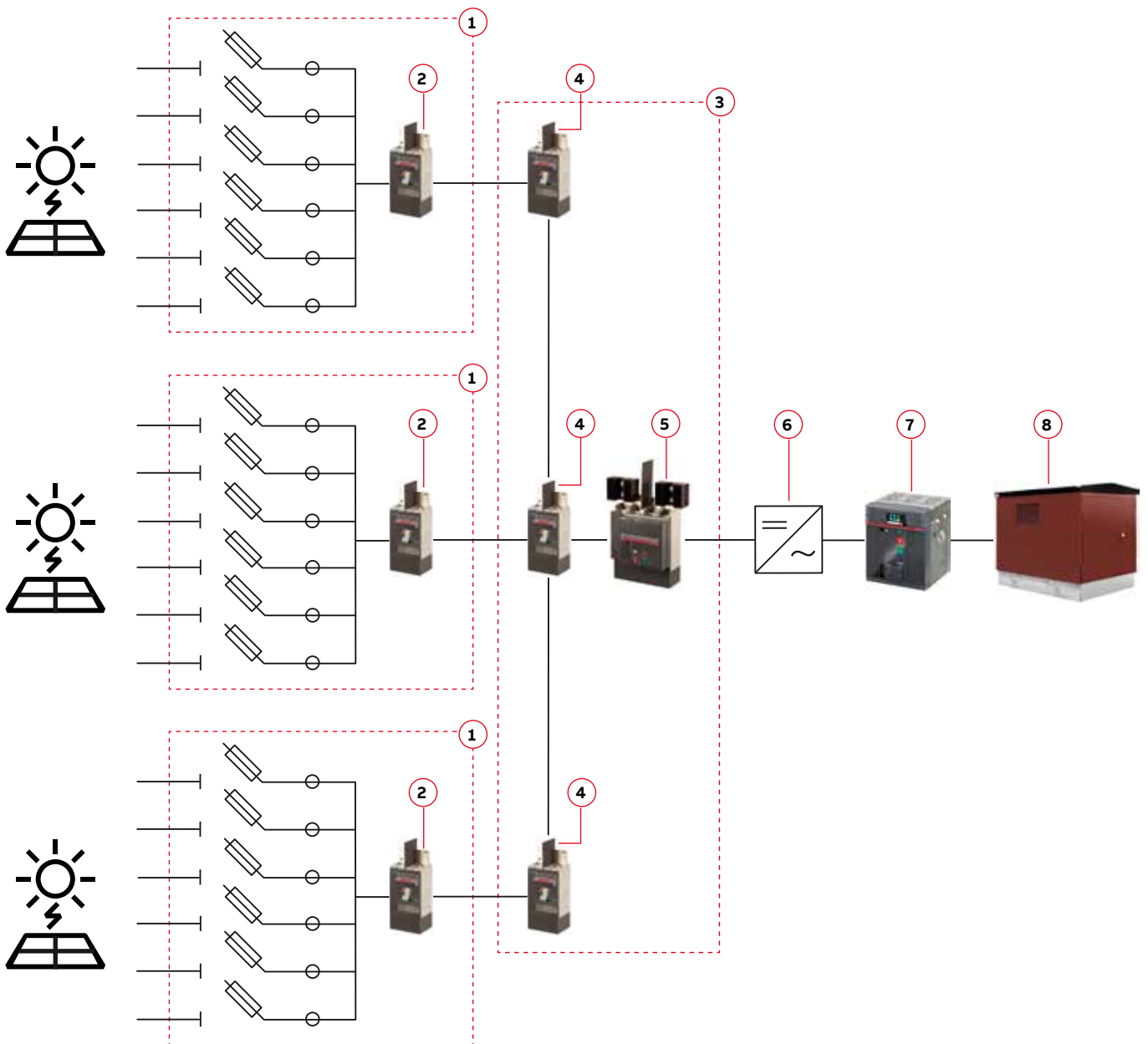

1. String Combiner
2. Molded Case Switch-Disconnecter (e.g. T4D/PV-E)
3. Recombiner
4. Molded Case Circuit-Breakers (e.g. T4N/PV-E)
5. Molded Case Switch-Disconnecter (e.g. T7D/PV-E)
6. Central inverter
7. Air Circuit-Breaker Emax 2
8. MV/LV Transformer - Compact Secondary Substation



CHAPTER 2

IEC applications

10-10	Flexibility guaranteed for new IEC compliant requirements
11-12	Ranges
13-15	Characteristic curves
16-19	Quick reference tables
20-20	Temperature performances and Wiring
21-21	Power Losses and Insulation distances
22-25	Dimensions

Flexibility guaranteed for new IEC compliant requirements

In accordance with IEC 60947-3 and IEC 60947-2 specifications, the **SACE Tmax PV** range proposes molded-case circuit-breakers and switch-disconnectors for standard 1100V DC applications as well as a versatile choice of extended ratings up to 1500V DC for today's increasingly demanding solar applications. Connection jumpers are available for the **SACE Tmax PV** IEC range for enhanced safety and ease of installation.

The **SACE Tmax PV** IEC range has been developed in order to protect the plant up to 1500V DC. In addition, the T4N/PV-E series of extremely compact molded-case circuit-breakers for applications up to 1500V DC with 100 to 250A rated current is the best solution for protection and isolation, mainly in PV systems where centralized inverters are used. Available in the 4-pole version, T4N/PV-E molded-case circuit-breakers are able to break short-circuit currents up to 25 kA in accordance with standard IEC 60947-2 edition 5.0 Annex P, and up to 10 kA in accordance with standard IEC60947-2 edition 4.2 and GB14048.2.

Thanks to dedicated jumper kits, all the poles can be connected to a single polarity source with 4 poles in series or, alternatively, to a dual polarity source with 2 poles in series on the positive supply and two on the negative supply. Similarly to all the other products in the range, T4N/PV-E molded-case circuit-breakers can be fitted with a vast assortment of electrical and mechanical accessories already available for the **SACE Tmax T** range.

Ranges

Common data	
Operating temperature	[°C] -25 °C ... +70 °C
Storage temperature	[°C] -40 °C ... +70 °C
Numbers of poles	4
Version	fixed

Altitude derating		
Altitude [mt]	In [%]	Ue [%]
2000	100	100
3000	98	88
4000	95	78
5000	85	68

Molded case switch-disconnectors up to 1100V DC in compliance with IEC 60947-3

Electrical characteristics

Tmax PV switch-disconnectors in compliance with the IEC60947-3	T1D/PV	T3D/PV	T4D/PV	T5D/PV	T6D/PV	T7D/PV ¹⁾
Rated service current in category DC22 B, Ie	(A) 160	200	250	500	800	1250-1600
Number of poles	(No.) 4	4	4	4	4	4
Rated service voltage, Ue	1100V DC	1100V DC	1100V DC	1100V DC	1100V DC	1100V DC
Rated impulse withstand voltage, Uimp	(kV) 8	8	8	8	8	8
Rated insulation voltage, Ui	(V) 1150V DC	1150V DC	1150V DC	1150V DC	1150V DC	1150V DC
Test voltage at industrial frequency for 1 minute	(V) 3500	3500	3500	3500	3500	3500
Rated short-circuit making capacity, switch-disconnector only, Icm	(kA) 1.92	2.4	3	6	9.6	19.2
Rated short-time withstand current for 1s, Icw	(kA) 1.92	2.4	3	6	9.6	19.2
Versions	F	F	F	F	F	F
Standard terminals	FC Cu	F	F	F	F	F
Mechanical life	(No. Operations) 15000	15000	7500	7500	7500	20000
Electrical life (operations @ 1100V DC)	(No. Operations) 500	500	500*	500*	500*	500*
Basic dimensions	W (mm/in)	102/4.02	140/5.52	140/5.52	186/7.33	280/11.02
	D (mm/in)	70/2.76	70/2.76	103.5/4.07	103.5/4.07	103.5/4.07
	H (mm/in)	130/5.12	150/5.91	205/8.07	205/8.07	268/10.55
Weight (with standard terminals only)	(kg/lbs) 1.2/2.65	2/4.41	3.05/6.72	4.15/9.15	12/26.46	12.5/27.56 (manual) 14/30.86 (motorized)

1) installation in vertical position only; * openings with SOR or UVR

Molded case switch-disconnectors up to 1500V DC in compliance with IEC 60947-3

Electrical characteristics

Tmax PV switch-disconnectors in compliance with the IEC60947-3	T4D/PV-E	T5D/PV-E	T7D/PV-E ¹⁾
Rated service current in category DC22 A, Ie	(A) 250	500	1250-1600
Number of poles	(No.) 4	4	4
Rated service voltage, Ue	1500V DC	1500V DC	1500V DC
Rated impulse withstand voltage, Uimp	(kV) 8	8	8
Rated insulation voltage, Ui	(V) 1500V DC	1500V DC	1500V DC
Test voltage at industrial frequency for 1 minute	(V) 3500	3500	3500
Rated short-circuit making capacity, switch-disconnector only, Icm	(kA) 3	6	19.2
Rated short-time withstand current for 1s, Icw	(kA) 3	6	19.2
Versions	F	F	F
Standard terminals	F	F	F
Mechanical life	(No. Operations) 7500	7500	20000
Electrical life (operations @ 1500V DC)	(No. Operations) 1000*	1000*	500*
Basic dimensions	W (mm/in)	140/5.52	186/7.33
	D (mm/in)	103.5/4.07	103.5/4.07
	H (mm/in)	205/8.07	205/8.07
Weight (with standard terminals only)	(kg/lbs) 3.05/6.72	3,15/9.15	14/30.86

1) installation in vertical position only. Motorized version; * openings with SOR or UVR

Ranges

Molded case circuit-breakers up to 1500V DC in compliance with IEC 60947-2

Whenever a consistent short-circuit current can be found, 1000V and 1500V DC automatic circuit-breakers are available in the Tmax T and Tmax PV range. Below is the IEC60947-2 automatic circuit-breaker offering at 1500V. For circuit-breakers at 1000V DC, see catalog Tmax T code 1SDC210015D0208.

Electrical characteristics

Tmax PV circuit-breaker in compliance with IEC 60947-2	T4N-PV/E
Frame size	(A) 250
Rated service current	(A) 100-250
Number of poles	(No.) 4
Rated service voltage, Ue	(V) 1500
Rated impulse withstand voltage, Uimp	(kV) 8
Rated insulation voltage, Ui	(V) 1500
Rated ultimate short-circuit breaking capacity @ 1500V DC, Icu	(kA) 25 according to IEC 60947-2 Edition 5.0 Annex P ($\tau = 1$ ms) (kA) 10 according to IEC 60947-2 Edition 4.2 and GB 14048.2 ($\tau = 5$ ms)
Rated service short-circuit breaking capacity @ 1500V DC, Ics	(kA) 20 according to IEC 60947-2 Edition 5.0 Annex P ($\tau = 1$ ms) (kA) 7.5 according to IEC 60947-2 Edition 4.2 and GB 14048.2 ($\tau = 5$ ms)
Trip Unit	TMF
Versions	F
Standard terminals	FCCu
Connections*	Jumpers
Mechanical life	(No. Operations) 7500
Electrical life (operations @ 1500V DC)	(No. Operations) 1000**
Basic dimensions	W (mm/in) 140/5.52 D (mm(in) 103.5/4.07 H (mm/in) 205/8.07
Weight (with standard terminals only)	(kg/lbs) 3.05/6.72

* Selection of one of the jumper connection options is mandatory; ** Opening with SOR or UVR

Characteristic curves

The IEC circuit-breaker T4 has an application range from 100A to 250A and breaking capacities up to 25kA at 1500V DC.

The circuit-breakers are fitted with thermal magnetic trip units and are used for protection of direct current in solar networks. They allow the

protection against overload with a thermal device that uses the bimetal technique, and protection against short-circuit with a magnetic device. T4 circuit-breakers is equipped with TMF thermomagnetic trip units with fixed thermal threshold and fixed magnetic threshold ($I_3 = 5 \times I_n$). The magnetic threshold is affected by a corrective factor of 15% because the TMF releases were originally calibrated to be used in AC networks. The curves for the PV line are shown below.

Trip curves

T4N/PV-E TMF 250

$I_n = 100 \dots 250A$

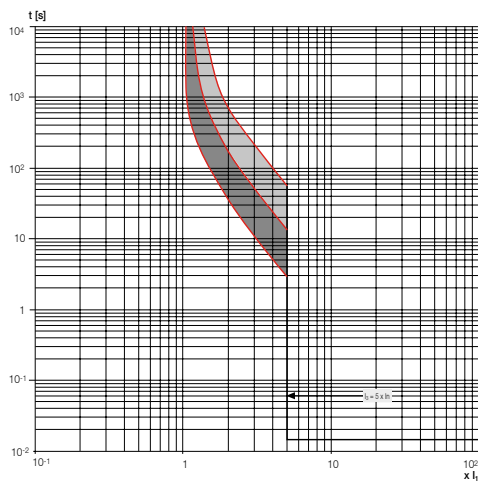

Characteristic curves

Limitation curves

T4N/PV-E
@ 1500V tau = 1ms

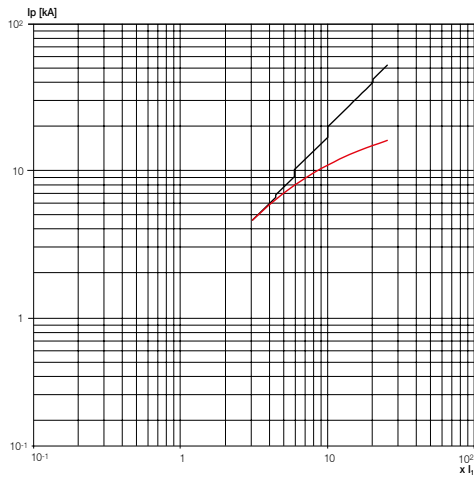

T4N/PV-E
@ 1500V tau = 5ms

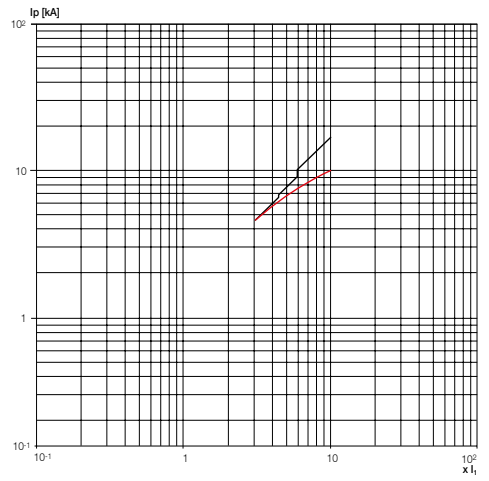

Specific let-through energy curves

T4N/PV-E
@ 1500V tau = 1ms

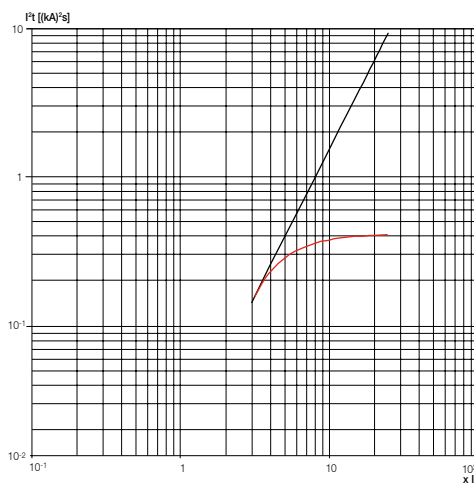

T4N/PV-E
@ 1500V tau = 5ms



ABB jumpers for pole-to-pole connection are the tested solution for a simplified and safe installation.

As already mentioned, another innovation of the Tmax PV series is the possibility of accessorizing the breakers and switch-disconnectors with suitable jumpers.

Tmax PV are 3 or 4 pole breakers: in order to break the direct current is necessary to put these poles in series on one, or both, the polarities.

Jumpers between poles are therefore necessary: for example a 4PS (PS = Poles in Series) jumper kit puts all 4 poles of a breaker in series on one polarity.

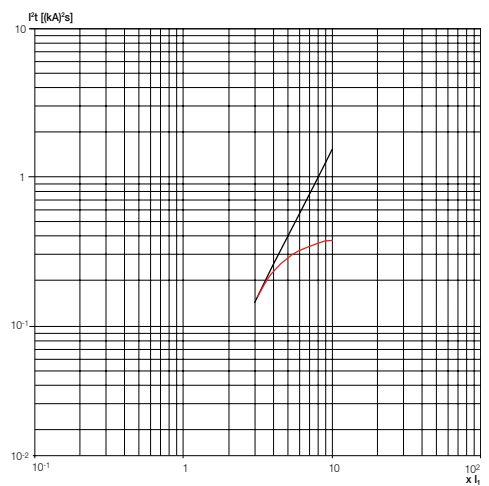
The jumpers are realized with or without heat sinks, depending on the breaker frame.

Jumper kits are divided into two versions: one for cabling all the poles on one single polarity (identified as 4PS or 3PS) and one for dividing the poles on both polarities (identified as 2+2PS or 2+1PS).

Performances shown in the tables are granted only if ABB original jumpers are used.

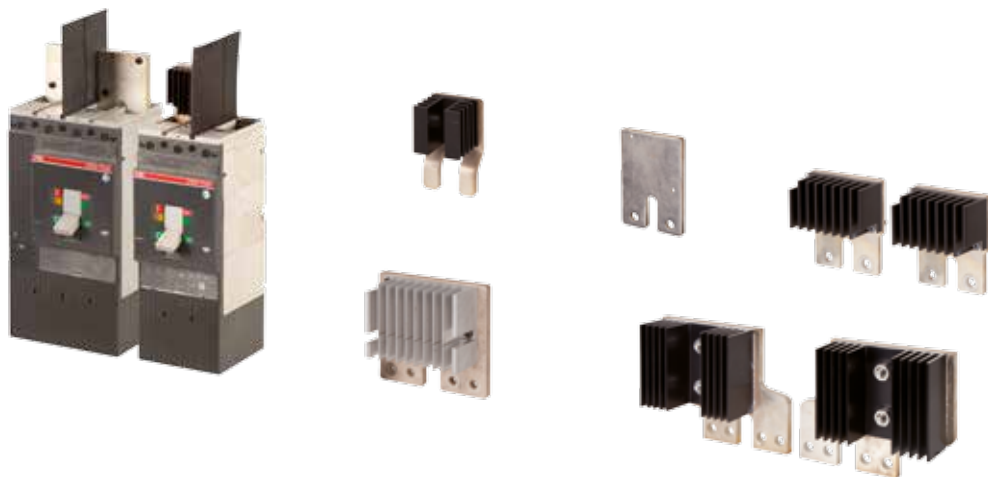









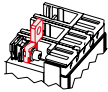

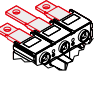
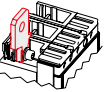
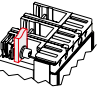
Quick reference tables

Tmax PV switch-disconnectors up to 1100V DC in compliance with IEC60947-3

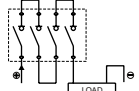
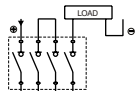
Configuration & Supply		EF	FCCu	FCCuAl	HR	ES	F
Size							
T1D/PV 	2+2 - lower		●	●		●	
	2+2 - upper		●	●		●	
	4PS - lower		●	●		●	
	4PS - upper		●	●		●	
T3D/PV 	2+2 - lower		●	●	●		●
	2+2 - upper		●	●	●		●
	4PS - lower		●	●	●		●
	4PS - upper		●	●	●		●

Tmax PV switch-disconnectors up to 1100V DC in compliance with IEC60947-3

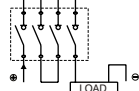
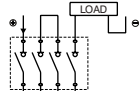
Configuration & Supply		EF	FCCu	FCCuAl	HR	ES	F
							
Size							
T4D/PV 	2+2 - lower		●	●	●		●
	2+2 - upper		●	●	●		●
	4PS - lower		●	●	●		●
	4PS - upper		●	●	●		●
	<hr/>						
T5D/PV 	2+2 - lower		●	●			●
	2+2 - upper		●	●			●
	4PS - lower		●	●			●
	4PS - upper		●	●			●







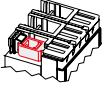

Quick reference tables

Tmax PV switch-disconnectors up to 1100V DC in compliance with IEC60947-3

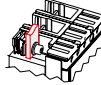
Configuration & Supply		EF	FCCu	FCCuAl	HR	ES	F
Size T6D/PV							
	2+2 - lower 	●		●			●
	2+2 - upper 			●			●
	4PS - lower 	●		●			●
	4PS - upper 			●			●
	T7D/PV						
	2+2 - lower 	●		●	● ¹⁾	●	●
	2+2 - upper 	●		●			●
	4PS - lower 	●		●		●	●
	4PS - upper 	●					●

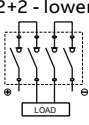
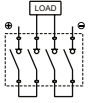
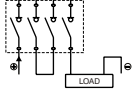
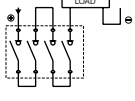
1) Vertical (VR) terminals can be used too

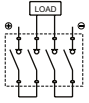
Tmax PV switch-disconnectors and circuit-breakers up to 1500V DC in compliance with IEC60947-2 and IEC60947-3

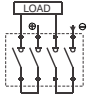
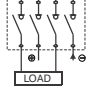
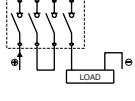
Configuration & Supply		FCCu	FCCuAl	F ³⁾
				
Size				
T4D/PV-E T4N/PV-E 	2+2 - lower 	●	●	●
	2+2 - upper 	● ²⁾	● ²⁾	● ²⁾
	4PS - lower 	●	●	●
	4PS - upper 	● ²⁾	● ²⁾	● ²⁾
T5D/PV-E 	2+2 - upper 	●		●
T7D/PV-E 	2+2 - upper 		●	●
	2+2 - lower 		● ¹⁾	● ¹⁾
	4PS - lower 		● ¹⁾	● ¹⁾

1) Valid only when 1250 A jumpers are used; 2) Not valid for T4N/PV-E 250; 3) Not valid for T4N/PV-E

Temperature performances and Wiring

Temperature performances of Tmax PV at temperatures other than 40 °C and for different altitude are reported in the following table.

Temperature [°C] / In [A]	T1D/PV	T3D/PV	T4D/PV	T5D/PV	T6D/PV	T7D/PV 1250	T7D/PV 1600
40	160	200	250	500	800	1250	1600
45	160	200	250	500	771	1225	1600
50	160	200	250	500	741	1199	1600
55	160	200	250	500	709	1171	1542
60	153	200	250	500	676	1141	1481
65	145	190	237	474	641	1109	1418
70	138	179	224	447	605	1074	1352

Wire options Tmax PV - IEC

Ambient temp.	40°C	40°C
Cable type	Copper (FcCu lugs)	Aluminum (FcCuAL lugs)
In (A)	Required wires (number x section)	Required wires (number x section)
T1D/PV		
160	1 x 70mm ^{2**}	Lug not available
T3D/PV		
200	1 x 95mm ²	1 x 150mm ^{2*}
T4D/PV		
250	1 x 120mm ²	1 x 185mm ^{2*}
T4D/PV-E		
250	1 x 120mm ²	1 x 185mm ^{2*}
T4N/PV-E		
100	1 x 35mm ²	Lug not available
125	1 x 50mm ²	Lug not available
160	1 x 70mm ²	Lug not available
200	1 x 95mm ²	Lug not available
250	1 x 120mm ²	Lug not available
T5D/PV		
500	2 x 150mm ²	2 x 240mm ^{2*}
T5D/PV-E		
500	2 x 150mm ²	2 x 240mm ^{2*}
T6D/PV		
800	2 x 240mm ^{2*}	Lug not available
T7D/PV		
1250	4 x 185mm ^{2*}	Lug not available
1600	4 x 240mm ^{2*}	Lug not available
T7D/PV-E		
1250	4 x 185mm ^{2*}	Lug not available
1600	4 x 240mm ^{2*}	Lug not available

*with FcCuAL; **Already installed

Power Losses and Insulation distances

When a current passes through a molded case circuit-breaker or switch-disconnector, it dissipates heat. The Tmax PV series is well known for having very few power losses.

Below, please find a table with information about IEC versions power losses.

Type	Version	In (A)	P (W/pole)
T1 MCS	IEC	160	15
T3 MCS	IEC	200	19
T4 MCS/MCCB	IEC	250	14
T5 MCS	IEC	500	30
T6 MCS	IEC	800	48
T7 MCS	IEC	1250	47
		1600	77

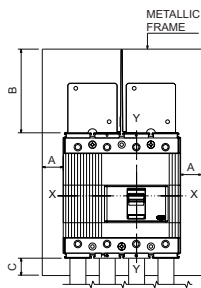

IEC 60947-3 Insulation distances for installation in metallic cubicle

	A [mm]		B [mm]		C [mm]	
	With jumpers	No jumpers	With jumpers	No jumpers	With jumpers	No jumpers
T1D/PV	55	20	100	50	100	20
T3D/PV	25	25	100	100	20	20
T4D/PV - T4D/PV-E	50	50	120	120	120	120
T4N/PV-E $\tau = 1\text{ms}$	50	-	210	-	210	-
$\tau = 5\text{ms}$	150	-	210	-	210	-
T5D/PV	57	25	120	120	105	105
T5D/PV-E	57	57	122,5	122,5	122,5	122,5
T6D/PV	50	50	100	100	110	110
T7D/PV 1250 - T7D/PV-E 1250	100	100	200	200	200	200
T7D/PV 1600 - T7D/PV-E 1600	130	130	200	200	200	200

Insulation distances in air between two Tmax PV with jumpers put side by side*

	[mm]
T1	60
T3	50
T4	100
T4N/PV-E $\tau = 1\text{ms}$	100
$\tau = 5\text{ms}$	300
T5	100
T6	100
T7	200

* insulation distances can be reduced using suitable insulation barriers between breakers

Dimensions

T1D/PV

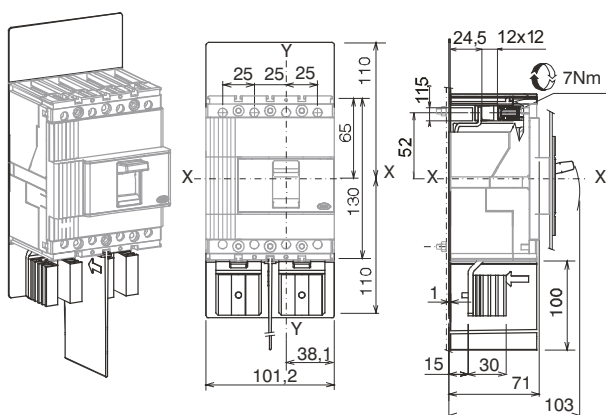

Installation instructions code 1SDH000777R0002 for other configurations and supply

T3D/PV

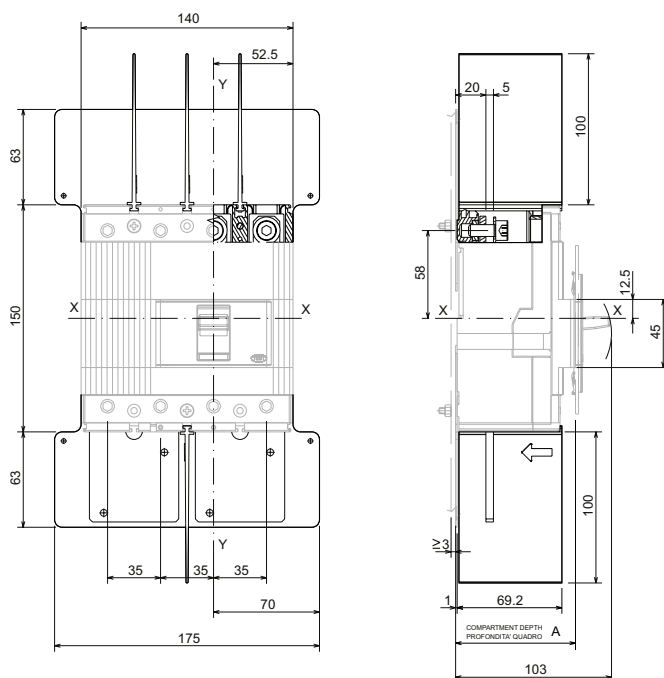

Installation instructions code 1SDH000778R0002 for other configurations and supply

T4D/PV - T4D/PV-E

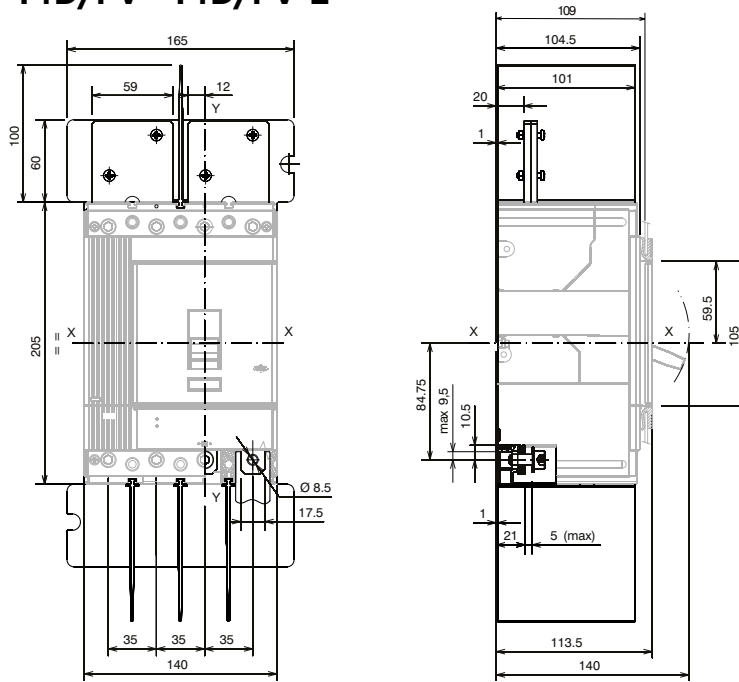

Installation instructions code 1SDH000779R0002 for other configurations and supply

T4N/PV-E

$\tau = 1\text{ms}$

$\tau = 5\text{ms}$

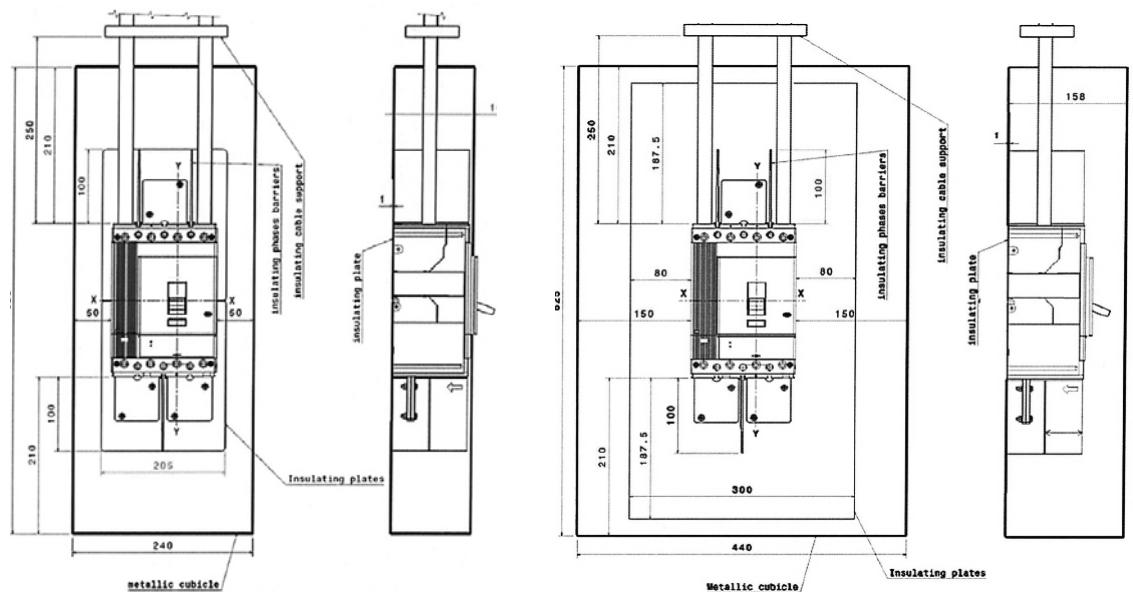

Installation instructions code 1SDH000779R0004 for other configurations and supply

Dimensions

T5D/PV

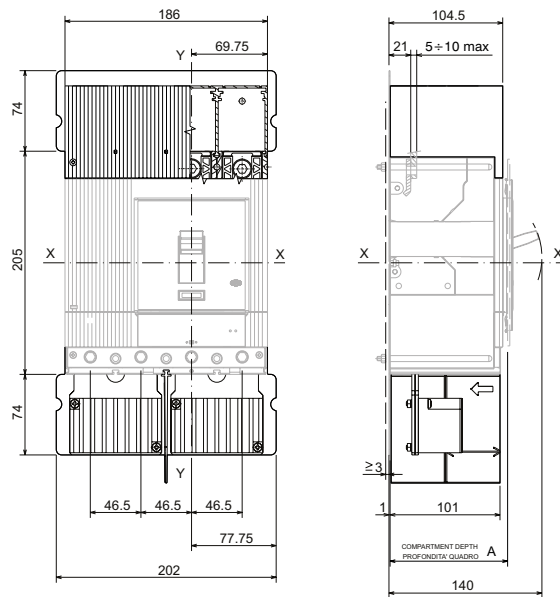

Installation instructions code 1SDH000780R0002 for other configurations and supply

T5D/PV-E

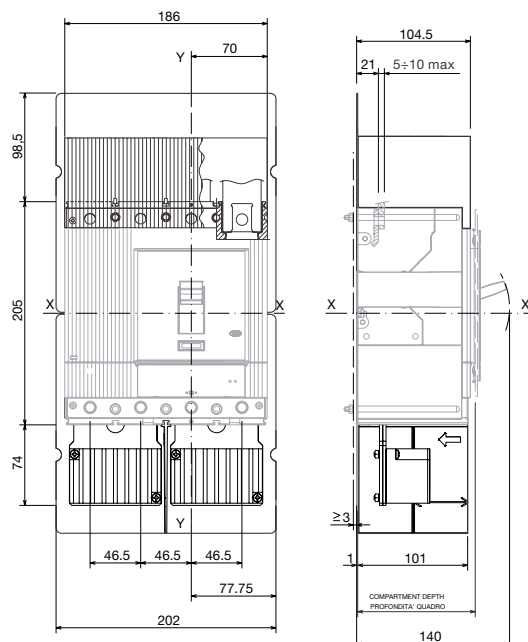

Installation instructions code 1SDH000780R0004 for other configurations and supply

SACE TMAX PV FOR PHOTOVOLTAIC APPLICATIONS ADAPTABILITY, VERSATILITY AND COMPLETE FREEDOM



CHAPTER 3

UL applications

28-28	Dedicated solutions compliant with UL Standards
29-29	Ranges
30-31	Characteristic curves
32-34	Quick reference tables
35-35	Temperature performances
36-36	Wiring
37-37	Power Losses
38-38	Insulation distances
39-41	Dimensions

Dedicated solutions compliant with UL Standards

The **SACE Tmax PV** UL range includes a full assortment of molded-case circuit-breakers and switch-disconnectors to UL 489B standards. Multiple versions that form a uniform product range and a complete portfolio of shared accessories, including the connection jumpers that are mandatory for **SACE Tmax PV** UL. The jumpers ensure ease of installation, safety and are fully compliant with UL regulations.

The **SACE Tmax PV** range of molded-case circuit-breakers and switch-disconnectors for photovoltaic applications now includes a UL489B type-approved version designed for 1500V DC installations with rated current up to 1200A. Compact and versatile, these UL circuit-breakers and switch-disconnectors are the best DC solution for the switchgear and inverters in all PV systems and in all markets where the North American regulations apply. A development of the switch-disconnector platform with T7N-D/PV-E integrated motor, the UL type-approved version provides optimized isolating performance over the entire current range.

Available in the 4-pole configuration, T7N-D/PV-E switch-disconnectors to UL standards include versions with an integrated motor-operator which do not require external components. This cuts down on overall size, reduces the amount of wiring and the installation time, all to the benefit of the final cost of the installation. All products can be equipped with the most common UL listed mechanical and electrical accessories already available for the **SACE Tmax T UL** molded-case circuit-breaker range.

Ranges

Common data	
Operating temperature	[°C] -25 °C ... +70 °C
Storage temperature	[°C] -40 °C ... +70 °C
Numbers of poles	3 - 4
Version	fixed

Altitude derating		
Altitude [mt]	In [%]	Ue [%]
2000	100	100
3000	98	88
4000	95	78
5000	85	68

Molded case switch-disconnectors up to 1500V DC in compliance with UL 489B

Electrical characteristics

Tmax PV UL switch-disconnectors	T1N-D/PV	T4N-D/PV	T5N-D/PV	T6N-D/PV	T7N-D/PV ¹⁾	T7N-D/PV-E ¹⁾
Rated service current	(A) 100	200	400	600-800	1000	1000-1200
Number of poles	(No.) 4	3	3	4	4	4
Rated service voltage	(V) 1000V DC	1000V DC	1000V DC	1000V DC	1000V DC	1500V DC
Short-circuit current withstand	(kA) 1.2	3	5	10	18	18
Magnetic override	(kA) -	3	5	10	-	-
Versions	F	F	F	F	F	F
Connections*	Jumpers	Jumpers	Jumpers	Jumpers	Jumpers	Jumpers
Terminals provided with Jumper kit (see ordering codes for details)	FCCu	FCCuAl	FCCu-ES	FCCuAl-EF	FCCuAl-F	1000A: F / FCCuAl 1200A: EF
Mechanical life	(No. Operations) 15000	7500	7500	7500	20000	20000
Electrical life (operations @ 1000V DC)	(No. Operations) 1000	1000**	500**	500**	500**	400**
Basic dimensions	W (mm/in)	102/4.02	105/4.13	140/5.52	280/11.02	280/11.02
	D (mm/in)	70/2.76	103.5/4.07	103.5/4.07	103.5/4.07	178/7.01
	H (mm/in)	130/5.12	205/8.07	205/8.07	268/10.55	268/10.55
Weight (with standard terminals only)	(kg/lbs) 1.2/2.65	2.35/5.18	3.25/7.17	12/26.46	14/30.86	14/30.86

1) installation in vertical position only * Selection of one of the jumper connection options is mandatory for Tmax PV UL ** openings with SOR or UVR

Molded case circuit-breakers up to 1000V DC in compliance with UL 489B

Whenever short and overload protection is required (like in recombiner boxes), 1000V DC automatic circuit-breakers are available in the Tmax PV range. Below is the UL489B automatic circuit-breaker offering.

Electrical characteristics

Tmax PV circuit-breaker in compliance with UL 489B	T4N/PV	T5N/PV	T6N/PV
Frame size	(A) 200	400	600-800
Rated service current	(A) 40-200	225-400	600-800
Number of poles	(No.) 3	3	4
Rated service voltage	(V) 1000V DC	1000V DC	1000V DC
Short-circuit interrupting rating @ 1000V DC	(kA) 7.5	5	10
Trip Unit	TMD/TMA	TMF/TMA	TMA
Versions	F	F	F
Standard terminals	F	F	F
Connections*	Jumpers	Jumpers	Jumpers
Terminals provided with Jumper kit (see ordering codes for details)	FCCuAl	FCCuAl-FCCu-ES	FCCuAl-EF
Mechanical life	(No. Operations) 7500	7500	7500
Electrical life (operations @ 1000 VDC)	(No. Operations) 1000**	500**	500**
Basic dimensions	W (mm/in)	105/4.13	140/5.52
	D (mm/in)	103.5/4.07	103.5/4.07
	H (mm/in)	205/8.07	205/8.07
Weight (with standard terminals only)	(kg/lbs) 2.35/5.18	3.25/7.17	12/26.46

* Selection of one of the jumper connection options is mandatory for Tmax PV UL ** openings with SOR or UVR

Characteristic curves

The UL circuit-breaker range is divided into three different frames, T4, T5 and T6, with an application range from 40A to 800A and breaking capacities up to 10kA at 1000V DC.

The circuit-breakers are fitted with thermal magnetic trip units and are used for protection of direct current in solar networks. They allow the protection against overload with a thermal device that uses the bimetal technique, and protection against short-circuit with a magnetic device. The range of T4, T5 and T6 circuit-breakers for photovoltaic applications includes the following:

- T4 (up to 50A) circuit-breakers equipped with TMD thermal magnetic trip units with adjustable thermal threshold ($I_1 = 0.7...1 \times I_n$) and fixed magnetic threshold ($I_3 = 10 \times I_n$).

- T4, T5 and T6 circuit-breakers equipped TMA thermal magnetic trip units with adjustable thermal threshold ($I_1 = 0.7...1 \times I_n$) and adjustable magnetic threshold ($I_3 = 5...10 \times I_n$). Only for T5 225, 250 and 300 A a special TMF trip unit is given: this TMF unit has fixed thermal threshold and adjustable magnetic threshold as indicated in the dedicated table ($I_3=1500...3000 \text{ A}$).

The magnetic threshold for Tmax T4, Tmax T5 and Tma T6 is affected by a corrective factor of 15% because the TMD and TMA releases were originally calibrated to be used in AC networks. The curves for the PV line are shown below.

T5/PV UL - Magnetic Threshold	
I_n	I_3
225	7.5 ... 15xI _n
250	7 ... 14xI _n
300	5.75 ... 11.5xI _n
400	5.75 ... 11.5xI _n

T4N/PV UL 200
I_n = 40 ... 200A

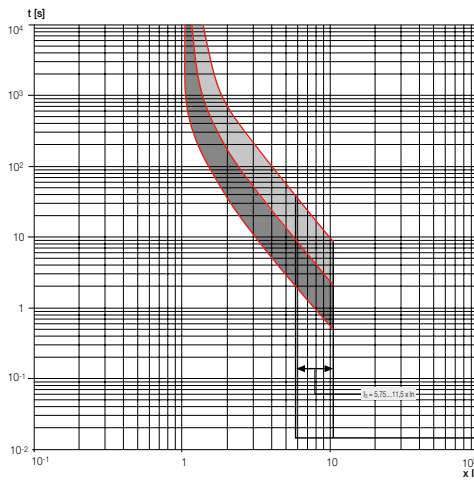

T5N/PV UL 400
I_n = 225, 250, 300, 400A

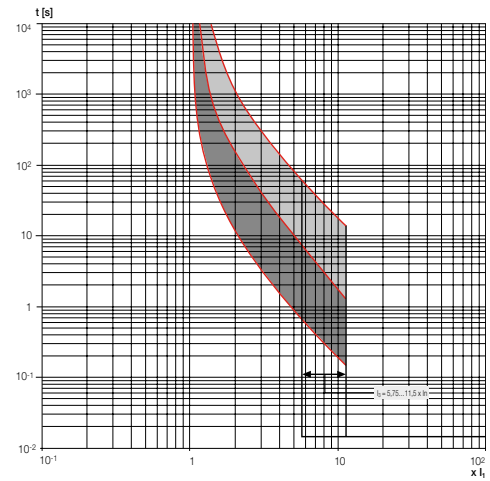

T6N/PV UL 600

In = 600A

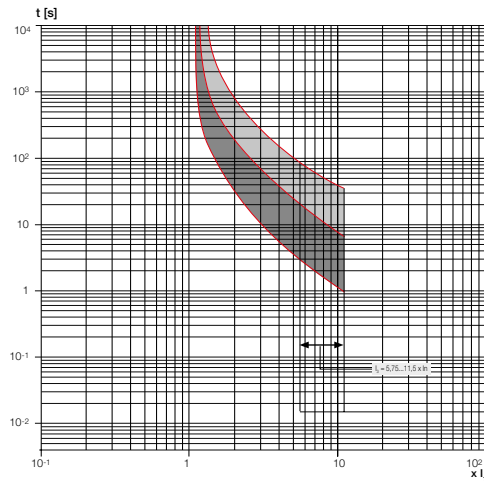

T6N/PV UL 800

In = 800A



ABB jumpers for pole-to-pole connection are the tested solution for a simplified and safe installation.

As already mentioned, another innovation of the Tmax PV series is the possibility of accessorizing the breakers and switch-disconnectors with suitable jumpers.

Tmax PV are 3 or 4 pole breakers: in order to break the direct current is necessary to put these poles in series on one, or both, the polarities.

Jumpers between poles are therefore necessary: for example a 4PS (PS = Poles in Series) jumper kit puts all 4 poles of a breaker in series on one polarity. One jumper kit ordering code includes 1, 2 or 3 jumpers, plus required lugs and accessories if needed.

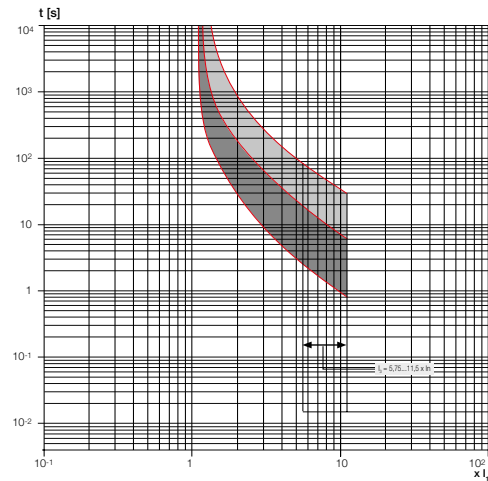



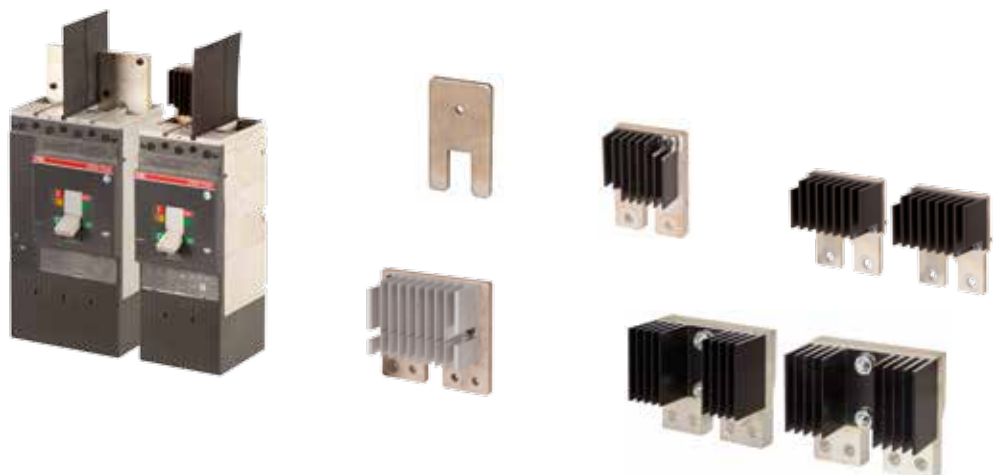

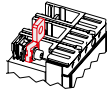

The jumpers are realized with or without heat sinks, depending on the breaker frame.

Jumper kits are divided into two versions: one for cabling all the poles on one single polarity (identified as 4PS or 3PS) and one for dividing the poles on both polarities (identified as 2+2PS or 2+1PS).

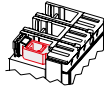
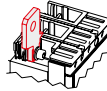
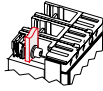

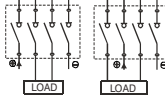
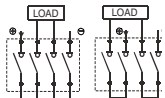
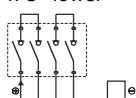
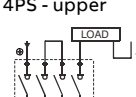

Quick reference tables

Tmax PV switch-disconnectors and automatic circuit-breakers up to 1000V DC in compliance with UL 489B

Configuration & Supply		EF	FCCu	FCCuAl	ES	F
						
Size						
T1N-D/PV 	2+2 - lower		●			
	2+2 - upper		●			
	4PS - lower		●			
	4PS - upper		●			
T4N-D/PV - T4N/PV 	2+1 - lower				● ¹⁾	
	3PS - lower				● ¹⁾	
	3PS - upper				● ¹⁾	

1) Included with jumpers kit

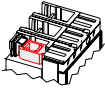
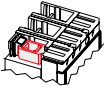
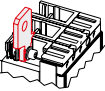
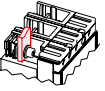
Tmax PV switch-disconnectors and automatic circuit-breakers up to 1000V DC in compliance with UL 489B

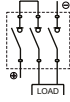
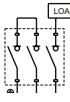
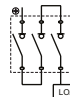
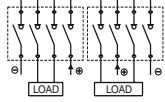
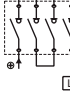
Configuration & Supply		EF	FCCu	FCCuAl	ES	F
						
Size						
	T5N-D/PV - T5N/PV	2+1 - lower 	● 1) 3)	● 2) 3)	● 4)	
		3PS - lower 	● 1) 3)	● 2) 3)	● 4)	
		3PS - upper 	● 1) 3)	● 2) 3)	● 4)	
	T6N-D/PV - T6N/PV	2+2 - lower 	● 4)	● 3)		
		4PS - lower 	● 4)	● 3)		

1) T5 300-400A only; 2) T5 225-250A only; 3) Included with jumper kit "cable type"; 4) Included with jumper kit "busbar type"

Quick reference tables

Tmax PV switch-disconnectors up to 1500V DC in compliance with UL 489B

Configuration & Supply		EF	FCCu	FCCuAl	ES	F
Size						
	T7N-D/PV	2+2 - lower				
					● 3)	● 4)
		2+2 - upper				
					● 3)	● 4)
		4PS - lower				
					● 3)	● 4)
		4PS - upper				
					● 3)	● 4)
	T7N-D/PV-E	2+2 - lower				
			● 1) 5)		● 2) 3)	● 2) 4)
		2+2 - upper				
			● 1) 5)		● 2) 3)	● 2) 4)
		4PS - lower				
			● 1) 5)		● 2) 3)	● 2) 4)
		4PS - upper				
			● 1) 5)		● 2) 3)	● 2) 4)

1) Mandatory for T7 1200A; 2) T7 1000A only; 3) Included with jumper kit "cable type"; 4) Included with jumper kit "busbar type"; 5) Included with jumper kit

Temperature performances

T1 MCS PV UL		T4 MCS PV UL		T5 MCS PV UL		T6 MCS PV UL		T7 MCS PV UL		T7 MCS PV UL	
With 40 °C Cables		With 40 °C Cables		With 40 °C Cables		With 40 °C Cables		1000A version		1200A version	
40	100	40	200	40	400	40	800	40	1000	40	1200
50	100	50	200	50	400	50	800	50	1000	50	1054
60	87	60	184	60	386	60	700	55	935	55	981
70	71	70	167	70	372	70	600	60	866	60	912
								65	791	65	835
								70	707	70	751

T4 PV UL range (MCCB)			
With 40 °C Cables		With 50 °C Cables	
refer to page 38 for cable dimensions		refer to page 38 for cable dimensions	
40	200	40	200
50	180	50	200
60	166	60	181
70	150	70	160

T5 PV UL (MCCB), 225A version			
With 40 °C Cables		With 50 °C Cables	
refer to page 38 for cable dimensions		refer to page 38 for cable dimensions	
40	225	40	225
50	200	50	225
60	175	60	200
70	160	70	175

T5 PV UL (MCCB), 250A version			
With 40 °C Cables		With 50 °C Cables	
refer to page 38 for cable dimensions		refer to page 38 for cable dimensions	
40	250	40	250
50	225	50	250
60	195	60	220
70	165	70	190

T5 PV UL (MCCB), 300A version			
With 40 °C Cables		With 50 °C Cables	
refer to page 38 for cable dimensions		refer to page 38 for cable dimensions	
40	300	40	300
50	270	50	300
60	240	60	265
70	210	70	230

T5 PV UL (MCCB), 400A version			
With 40 °C Cables		With 50 °C Cables	
refer to page 38 for cable dimensions		refer to page 38 for cable dimensions	
40	400	40	400
50	387	50	400
60	373	60	380
70	300	70	360

T6 PV UL (MCCB), 600A version			
With 40 °C Cables		With 50 °C Cables	
refer to page 38 for cable dimensions		refer to page 38 for cable dimensions	
40	600	40	600
50	600	50	600
60	525	60	525
70	450	70	450

T6 PV UL (MCCB), 800A version	
With 40 °C Cables	
refer to page 38 for cable dimensions	
40	800
50	800
60	700
70	600

Test performed by busbars

Wiring

Please note that for UL MCCBs two deratings are given, according to UL489B: one when 40°C cables are used, and one when 50°C cables are used. Cables dimensions are given by UL489B.

Below, please find the relevant cabling info.

Wire options for Tmax PV - UL				
Ambient temp.	40°C		50°C	
Cable type	Copper	Aluminum	Copper	Aluminum
In (A)	required wires (number x section)		required wires (number x section)	
T1N-D/PV				
100	1 x 3 AWG	Lug not available	1 x 1/0 AWG	Lug not available
T4N-D/PV				
200	1 x 3/0 AWG	1 x 250kcmil	1 x 300kcmil	Lug not available
T4N/PV				
40	1 x 8 AWG	1 x 8 AWG	1 x 6 AWG	1 x 4 AWG
50	1 x 8 AWG	1 x 6 AWG	1 x 4 AWG	1 x 3 AWG
80	1 x 4 AWG	1 x 2 AWG	1 x 2 AWG	1 x 1/0 AWG
100	1 x 3 AWG	1 x 1 AWG	1 x 1/0 AWG	Lug not available
125	1 x 1 AWG	1 x 2/0 AWG	1 x 2/0 AWG	1 x 4/0 AWG
150	1 x 1/0 AWG	1 x 3/0 AWG	1 x 3/0 AWG	1 x 250kcmil
200	1 x 3/0 AWG	1 x 250kcmil	1 x 300kcmil	Lug not available
T5N-D/PV				
400	2 x 3/0 AWG	Lug not available	2 x 300kcmil	Lug not available
T5N/PV				
225	1 x 4/0 AWG	1 x 300kcmil	1 x 350kcmil	2 x 3/0 AWG
250	1 x 250kcmil	1 x 350kcmil	1 x 400kcmil	Lug not available
300	1 x 350kcmil	Lug not available	2 x 3/0 AWG	Lug not available
400	2 x 3/0 AWG	Lug not available	2 x 300kcmil	Lug not available
T6N-D/PV				
600	2 x 350kcmil	2 x 500kcmil	3 x 300kcmil	3 x 400kcmil
T6N/PV				
600	2 x 350kcmil	2 x 500kcmil	3 x 300kcmil	3 x 400kcmil
T7N-D/PV				
1000	3 x 400kcmil	4 x 350kcmil	4 x 400kcmil	Lug not available
T7N-D/PV-E				
1000	3 x 400kcmil	4 x 350kcmil	4 x 400kcmil	Lug not available

Power Losses

When a current passes through a molded case circuit-breaker or switch-disconnector, it dissipates heat. The Tmax T series is well known for having very few power losses. Below, please find a table with information about UL versions power losses.

Type	Trip Unit	Version	In (A)	P (W/pole)			
T1	MCS	UL	100	7.5			
T4	MCS	UL	200	8.9			
			40	3,8			
	TMD	UL	50	3,9			
			80	6,4			
			100	7,6			
			125	7,9			
			150	8			
T5	TMA	UL	200	10			
			400	19			
			400	29			
			T6	MCS	UL	600	31
						800	48
						TMA	UL
800	50						
T7	MCS	UL	1000	30			
			1200	47			

Insulation distances

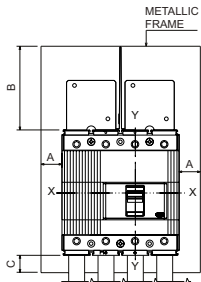

UL489 Insulation distances for installation in metallic cubicle

	A [mm]	B [mm]	C [mm]
T1N-D/PV	55	100	100
T4N-D/PV - T4N/PV	50	200	200
T5N-D/PV - T5N/PV	57	200	200
T6N-D/PV* - T6N/PV	70	220	110
T7N-D/PV - T7N-D/PV-E	165	230	200

Insulation distances in air between two Tmax PV with jumpers put side by side*

	[mm]
T1	55
T3	-
T4	100
T5	100
T6	265
T7	330

* insulation distances can be reduced using suitable insulation barriers between breakers

UL489B cubicle dimensions for Tmax PV

	H [mm]	W [mm]	D [mm]
T1/PV UL	370	245	72
T4/PV UL	520	420	200
T5/PV UL	710	550	175
T6/PV UL	704	540	173
T7/PV UL	704	610	173

Dimensions

T1N-D/PV

4PS solution, Lower Supply

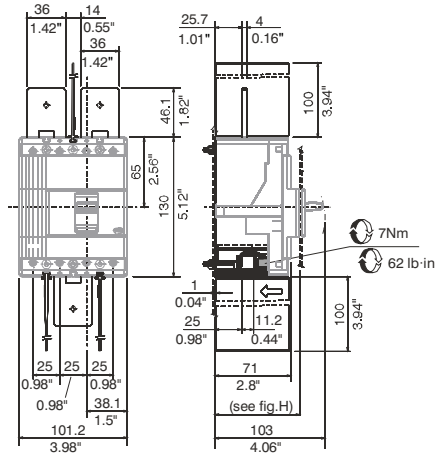

Installation instructions code 1SDH000777R0003 for other configurations and supply

T4N-D/PV - T4N/PV

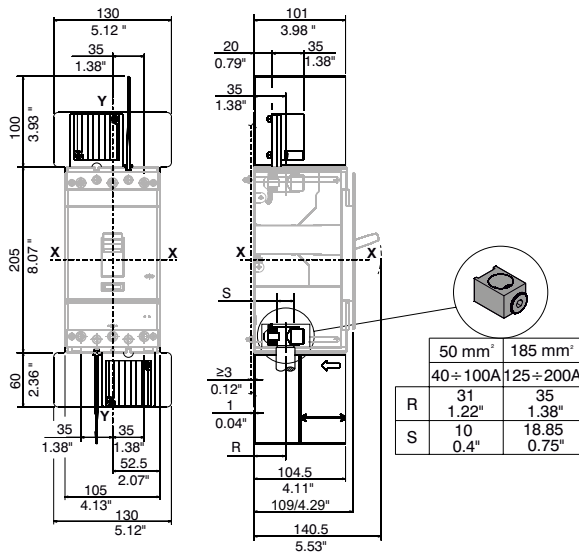

Installation instructions code 1SDH000779R0003 for other configurations and supply

Dimensions

T5N-D/PV - T5V/PV

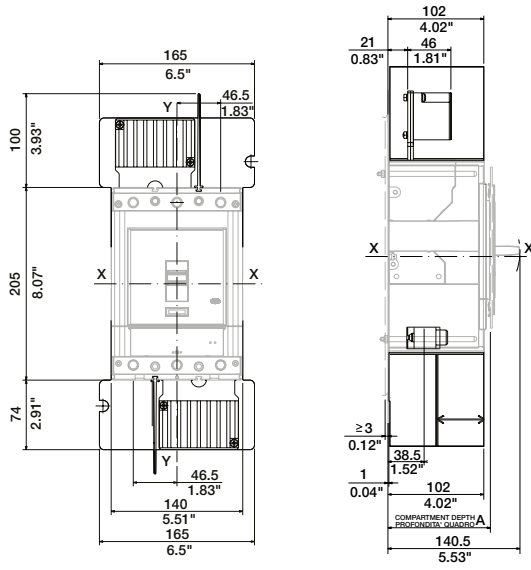

Installation instructions code 1SDH000780R0003 for other configurations and supply

T6N-D/PV - T6N/PV

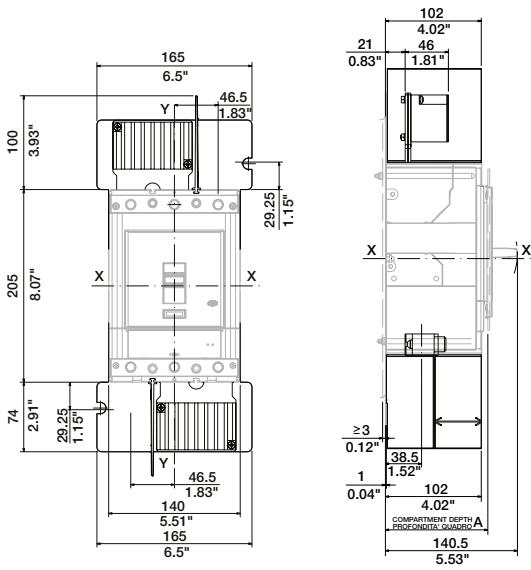

Installation instructions code 1SDH000781R0003 for other configurations and supply



CHAPTER 4

800V AC applications

44-44	Full protection for string inverters with 800V AC output
45-45	Ranges
46-47	Characteristic curves
48-48	Temperature performances
49-49	Wiring
50-50	Power Losses
51-51	Insulation distances
52-55	Dimensions

Full protection for string inverters with 800V AC output

Once again, ABB meets market demands by proposing a series of AC products for this type of application, designed to address two distinct trends in state-of-the-art plant design: the growing number of PV systems using string inverters and the increase in rated voltages.

SACE Tmax PV T4V-HA and T5V-HA circuit-breakers for AC applications are now available in UL type-approved versions and versions that conform to Standards IEC 60947-2 and GB14048.2. The T4V-HA version bearing the three UL, IEC and CCC marks and T5V-HA bearing both the IEC and UL marks can be supplied.

Size T4 controls currents up to 250A and can break short-circuit current up to 25kA, while size T5 controls currents up to 630A and breaks short-circuit current up to 32kA.

To be highlighted that T4V-HA UL up to 150A and T5V-HA UL are 100% rated. Ideal for protecting AC switchgear and string inverters, these circuit-breakers can be integrated with the entire range of electrical and mechanical accessories already available for the **SACE Tmax T** molded-case circuit-breaker range.

Ranges

IEC

	T4V-HA	T5V-HA			
Rated uninterrupted current [A]	80, 100, 125, 160, 200, 250	320	400	500	630
Rated service voltage [V]	800	800			
Rated impulse withstand voltage, Uimp [kV]	8	8			
Rated insulation voltage, Ui [V]	1000	1000			
Distribution System	IT, TN	IT, TN			
Rated breaking capacity, Icu [kA]	25	32			
Rated service breaking capacity, Ics [kA]	12	16			
Category of use (IEC 60947-2)	A	A			
Isolation behaviour	Yes	Yes			
Reference Standards	IEC60947-2/GB14048.2	IEC60947-2/GB14048.2			
Product Certification	IEC - CCC	IEC - CCC			
Trip unit type	TMA	TMA			PR221
Poles	3P/4P	3P/4P			
Class of pollution	III	III			
Derating on uninterrupted current @ 4000m	93%	93%			
Working Temperature [°C]	-25 + 70	-25 + 70			
Electrical life [No. Operations]	2000	1000			
Mechanical life [No. Operations]	20000	20000			
Version	F	F			
Terminals (cables, busbars)	Front, FcCuAl (1x185), FcCu (1x185)	Front, FcCuAl (1x240), FcCu (1x240)		Front	

UL

	T4V-HA	T5V-HA
Rated uninterrupted current [A]	80, 100, 125, 150, 200	300
Rated	100% up to 150A, 80% at 200A	100%
Rated service voltage [V]	800	800
Rated impulse withstand voltage, Uimp [kV]	8	8
Rated insulation voltage, Ui [V]	1000	1000
Distribution System	Δ	Δ
Short circuit interrupting rating [kA]	25	25
Isolation behaviour	Yes	Yes
Reference Standards	UL489	UL489
Product Certification	UL - IEC - CCC	UL - IEC
Trip unit type	TMA	TMA, PR221
Poles	3P/4P	3P/4P
Class of pollution	III	III
Derating on uninterrupted current @ 4000m	93%	93%
Working Temperature [°C]	-25 + 70	-25 + 70
Electrical life [No. Operations]	4000	1000
Mechanical life [No. Operations]	20000	20000
Version	F	F
Terminals	FcCuAl (1x350kcmil)	FcCuAl (1x500kcmil)

Characteristic curves

Circuit-breakers with thermomagnetic trip units - IEC

T4 TMA
In = 80...250A

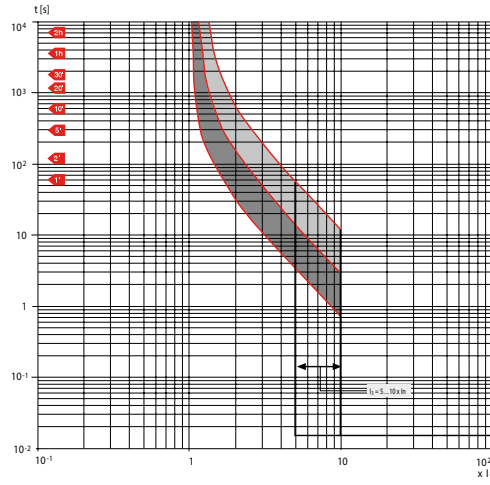

T5 TMA
In = 320...500A

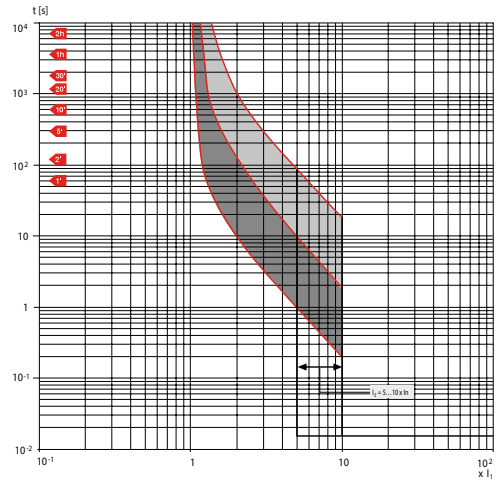

Circuit-breakers with electronic trip units - IEC

T5 PR221
L-I Functions
In = 630A I3 max = 9.5 x In

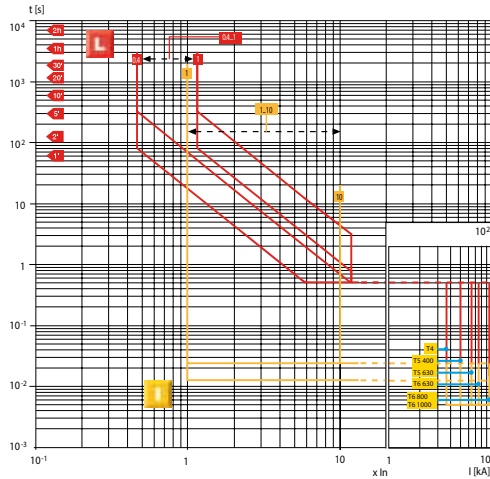

T5 PR221
L-S Functions
In = 630A I2 max = 9.5 x In

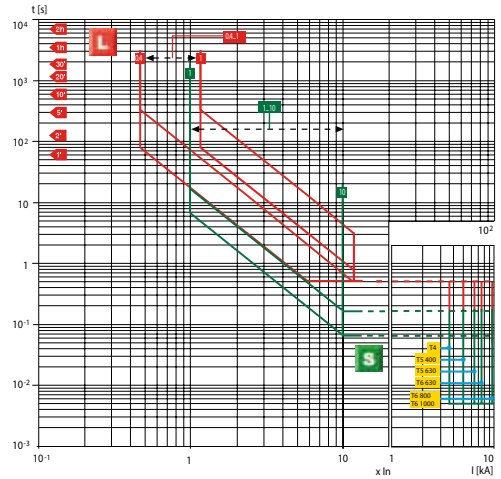

Circuit-breakers with thermomagnetic trip units - UL

T4 TMA
In = 80...200A

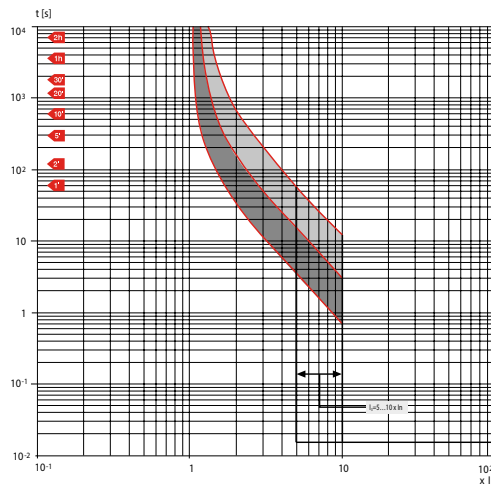

T5 TMA
In = 300A

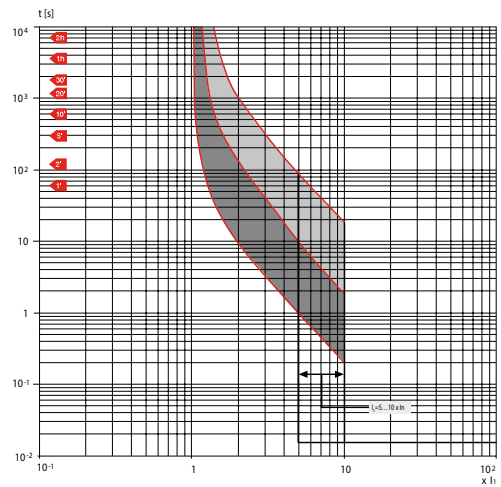

Circuit-breakers with electronic trip units - UL

T5 PR221
L-I Funcions
In = 300A

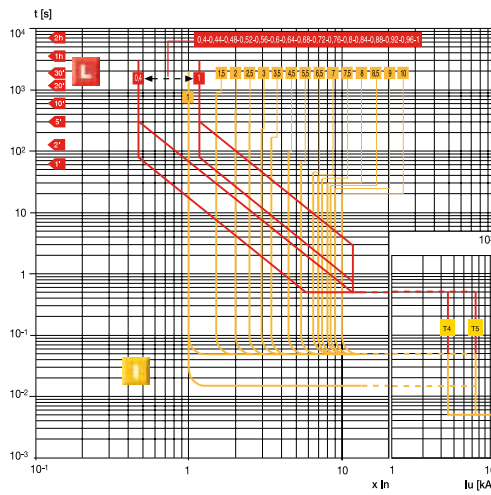

T5 PR221
L-S Funcions
In = 300A

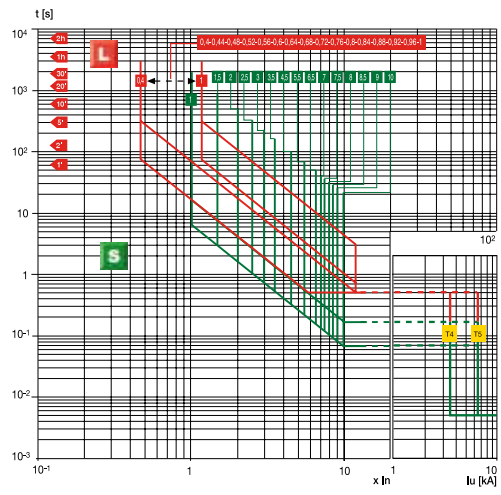

Temperature performances

IEC

Circuit-breaker with electronic trip unit

	up to 40°C		50°C		60°C		70°C	
	I _{max} [A]	I ₁	I _{max} [A]	I ₁	I _{max} [A]	I ₁	I _{max} [A]	I ₁
Tmax T5 630								
	630	1	580	0.92	529	0.84	479	0.76

Circuit-breaker with thermomagnetic trip units

In [A]	10°C		20°C		30°C		40°C		50°C		60°C		70°C	
	MIN	MAX	MIN	MAX	MIN	MAX	MIN	MAX	MIN	MAX	MIN	MAX	MIN	MAX
Tmax T4														
80	69	98	64	96	60	86	56	80	52	74	46	66	41	58
100	83	118	79	113	74	106	70	100	66	95	59	85	52	75
125	101	145	98	140	94	134	88	125	80	115	73	105	66	95
160	130	185	123	176	118	168	112	160	105	150	98	140	91	130
200	161	230	154	220	147	210	140	200	133	190	122	175	112	160
250	200	285	193	275	183	262	175	250	168	240	161	230	154	220
Tmax T5														
320	258	368	245	350	234	335	224	320	213	305	200	285	184	263
400	325	465	309	442	294	420	280	400	266	380	248	355	227	325
500	434	620	406	580	378	540	350	500	315	450	280	400	241	345

UL

Circuit-breaker with electronic trip unit

	up to 140°F/40°C		122°F/50°C		140°F/60°C		158°F/70°C	
	I _{max} [A]	I ₁	I _{max} [A]	I ₁	I _{max} [A]	I ₁	I _{max} [A]	I ₁
Tmax T5 300								
	300	1	264	0.88	228	0.76	189*	0.63

* In order to grant 288A it is necessary to use a cable size of 500kmcil with lug 1x240mm²

Circuit-breaker with thermomagnetic trip units

In [A]	50°F/10°C		68°F/20°C		86°F/30°C		104°F/40°C		122°F/50°C		140°F/60°C		158°F/70°C	
	MIN	MAX	MIN	MAX	MIN	MAX	MIN	MAX	MIN	MAX	MIN	MAX	MIN	MAX
Tmax T4														
80	94	90	85	80	75	68	62							
100	118	112	106	100	95	85	77							
125	148	140	133	125	119	106	100							
150	177	168	159	150	143	127	114							
200	236	224	212	200	190	170	167							
Tmax T5														
300	241...345	230...328	220...314	210...300	200...286	187...267	178...254							

Wiring

IEC

Wire options Tmax T4V-HA IEC and T5V-HA		
Ambient temp.	40°C	
Cable type	Copper	Aluminum
In (A)	required wires (number x section)	
T4V-HA		
80	1 x 25mm ²	1 x 35mm ² *
100	1 x 35mm ²	1 x 50mm ² *
125	1 x 50mm ²	1 x 70mm ² *
160	1 x 70mm ²	1 x 120mm ² *
200	1 x 95mm ²	1 x 150mm ² *
250	1 x 150mm ²	1 x 185mm ² *
T5V-HA		
320	1 x 185mm ²	2 x 120mm ² *
400	1 x 240mm ²	2 x 150mm ² *
500	2 x 150mm ² *	2 x 240mm ² *
630	2 x 185mm ² *	Lug not available

*with FcCuAL

UL

Wire options Tmax T4V-HA UL and T5V-HA		
Ambient temp.	40°C	
Cable type	Copper	Aluminum
In (A)	required wires (number x section)	
T4V-HA		
80	1 x 4 AWG	1 x 2 AWG
100	1 x 3 AWG	1 x 1 AWG
125	1 x 1 AWG	1 x 2/0 AWG
150	1 x 1/0 AWG	1 x 3/0 AWG
200	1 x 3/0 AWG	1 x 250kcmil
T5V-HA		
300	1 x 350kcmil	1 x 500kcmil

Power losses

IEC

Type	Trip Unit	In [A]	P [w/pole]
T4	TMA	80	4,6
		100	5,2
		125	6,2
		160	7,4
		200	9,9
		250	13,7
T5	TMA	320	13,6
		400	19,5
		500	28,8
	ELT	630	41,0

UL

Type	Trip Unit	In [A]	P [w/pole]
T4	TMA	80	4,6
		100	5,2
		125	5,7
		150	6,9
		200	9,9
		T5	TMA
ELT	300		9,3

Insulation distances

T4V-HA Un ≤ 800V AC

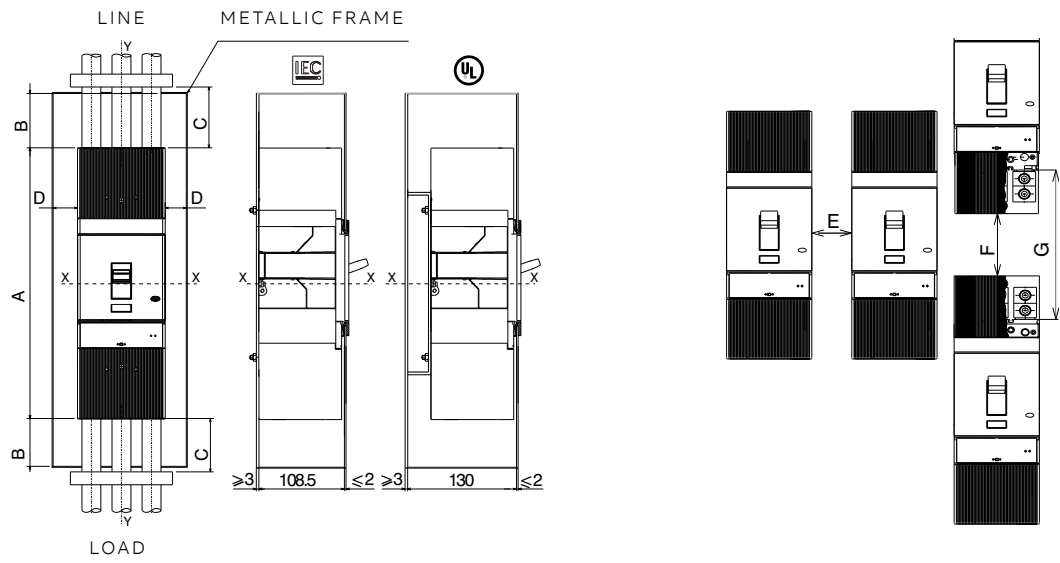

	A	B	C	D	E	F	G
IEC	325	150	160	50	100	300	420
UL	325	90.5	100	54.5	109	181	301

T5V-HA Un ≤ 800V AC

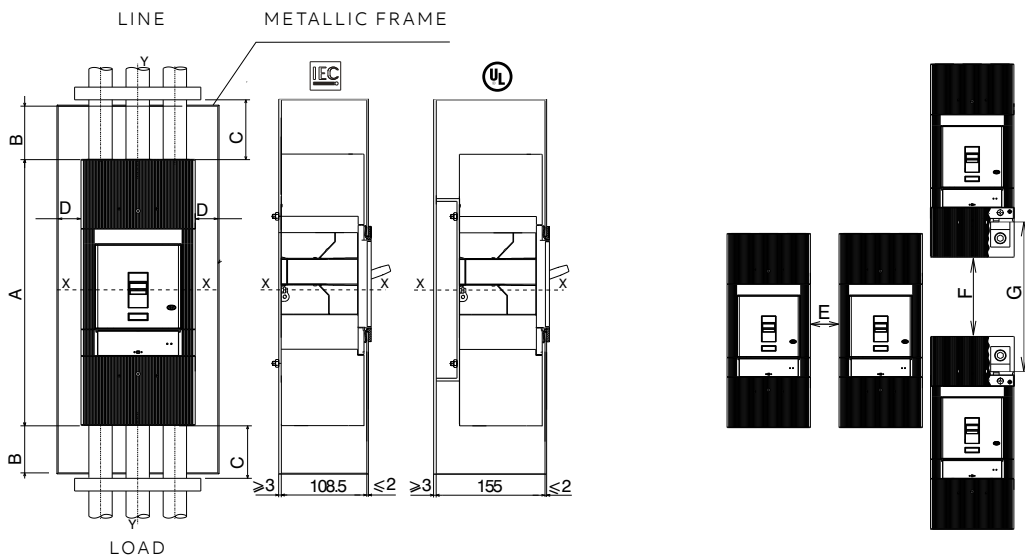

	A	B	C	D	E	F	G
IEC	325	150	160	50	100	300	420
UL	325	90.5	100	121	242	181	301

Dimensions

T4V-HA IEC/UL

F

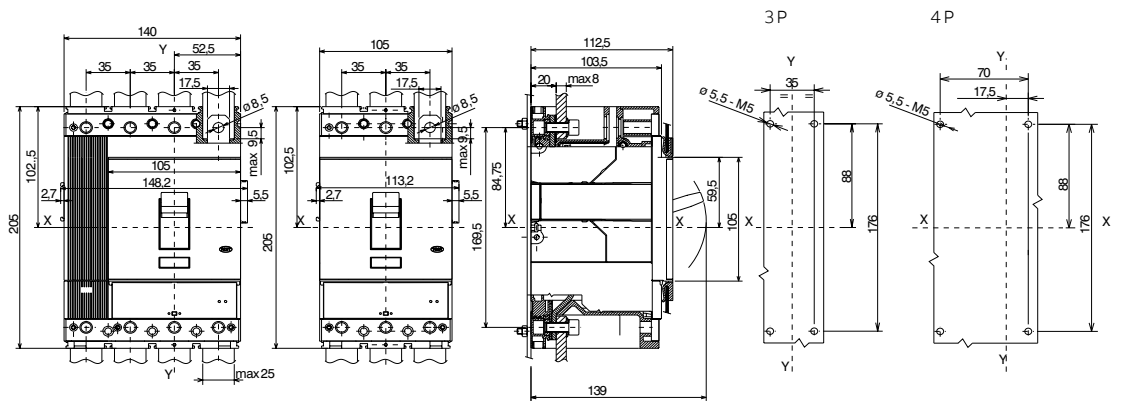

Installation instructions code 1SDH001607R0001 for other configurations and supply

T4V-HA IEC/UL

FC Cu

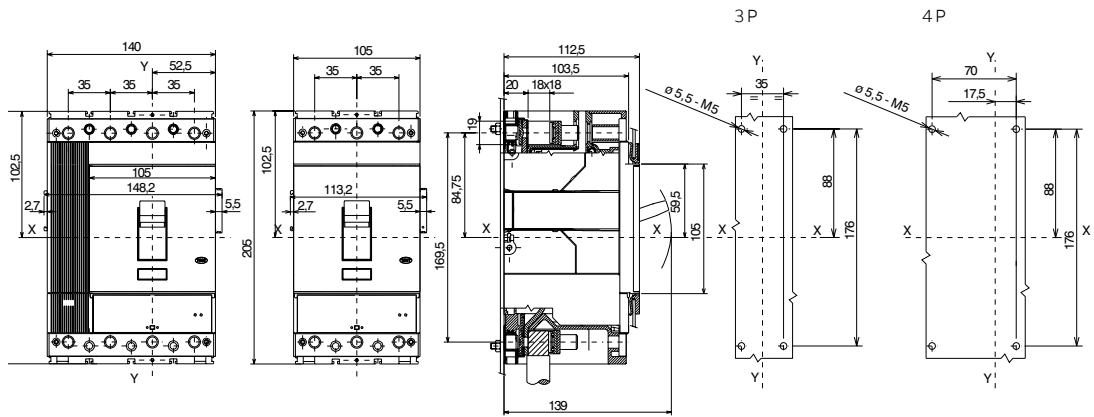

Installation instructions code 1SDH001607R0001 for other configurations and supply

T5V-HA IEC/UL

FC Cu Al

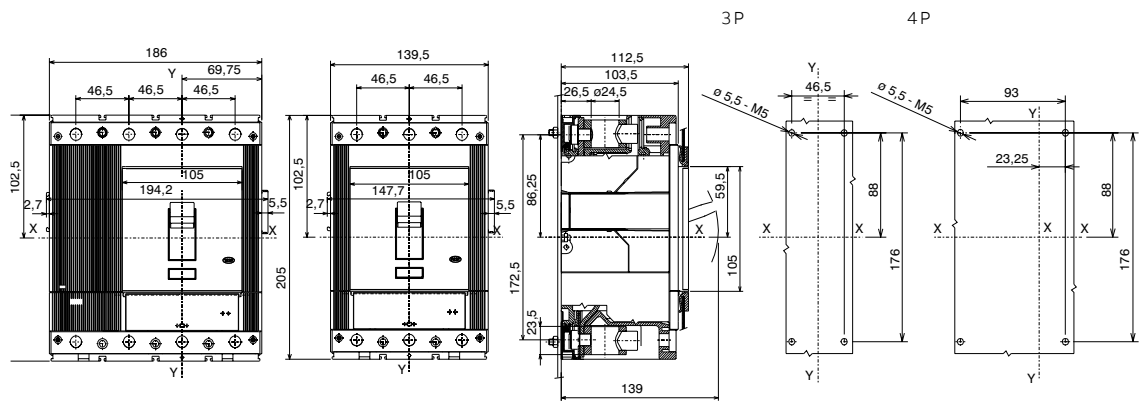

Installation instructions code 1SDH001607R0001 for other configurations and supply

T5V-HA IEC/UL

HIGH TERMINAL COVERS

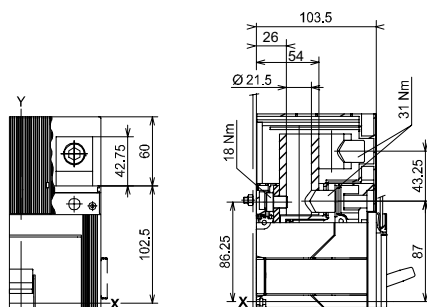

Installation instructions code 1SDH001608R0001 for other configurations and supply.

NOTE: High Terminal Covers are mandatory for top and bottom and already included in the circuit-breakers ordering codes



CHAPTER 5

Ordering codes

- | | |
|--------------|---|
| 58-59 | IEC range ordering codes |
| 60-61 | UL range ordering codes |
| 62-63 | 800V AC IEC and UL ranges ordering codes |

IEC range ordering codes

Switch-disconnector	
Code	Description
1SDA069816R1	T1D/PV 160 4p F FC Cu 1100V DC
1SDA082693R1	T3D/PV 200 4p F F 1100V DC
1SDA069823R1	T4D/PV 250 4p F F 1100V DC
1SDA069824R1	T5D/PV 500 4p F F 1100V DC
1SDA069825R1	T6D/PV 800 4p F F 1100V DC
1SDA069826R1	T7D/PV 1250 4p F F 1100V DC
1SDA069827R1	T7D/PV 1250 4p F F M 1100V DC
1SDA069828R1	T7D/PV 1600 4p F F 1100V DC
1SDA069829R1	T7D/PV 1600 4p F F M 1100V DC
1SDA073559R1	T4D/PV-E 250 4p F F 1500V DC
1SDA076898R1	T5D/PV-E 500 4p FF 1500V DC
1SDA073560R1	T7D/PV-E 1250 4p F F M 1500V DC
1SDA073561R1	T7D/PV-E 1600 4p F F M 1500V DC

Circuit-breakers	
Code	Description
1SDA082910R1	T4N/PV-E 250 TMF 100 4p F F 1500V DC
1SDA082911R1	T4N/PV-E 250 TMF 125 4p F F 1500V DC
1SDA082912R1	T4N/PV-E 250 TMF 160 4p F F 1500V DC
1SDA082913R1	T4N/PV-E 250 TMF 200 4p F F 1500V DC
1SDA082914R1	T4N/PV-E 250 TMF 250 4p F F 1500V DC

For circuit-breakers at 1000V DC, see catalog Tmax T code 1SDC210015D0208.

Jumper kit	
Code	Description
1SDA069876R1	KIT 2 JUMPER 2+2PS T1D/PV 160 4p
1SDA069877R1	KIT 3 JUMPER 4PS T1D/PV 160 4p
1SDA076162R1	KIT 2JUMPER U 2+2PS T3D/PV 200
1SDA076163R1	KIT 3JUMPER U 4PS T3D/PV 200
1SDA070454R1	KIT 2JUMPER U 2+2PS T4D/PV 250
1SDA070455R1	KIT 3JUMPER U 4PS T4D/PV 250
1SDA085254R1	KIT 2JUMPER U 2+2PS T4N/PV-E 200 1500V DC
1SDA085255R1	KIT 3JUMPER U 4PS T4N/PV-E 200 1500V DC
1SDA085253R1	KIT 3JUMPER U 4PS T4N/PV-E 250 1500V DC
1SDA085251R1	KIT 2 JUMPER U 2+2PS T4N/PV-E 250 1500V DC
1SDA070456R1	KIT 2JUMPER U 2+2PS T5D/PV 500
1SDA070457R1	KIT 3JUMPER U 4PS T5D/PV 500
1SDA076899R1	KIT 2JUMPER U 2+2PS T5D/PV-E 500 1500V DC
1SDA070491R1	KIT 2JUMPER U 2+2PS T6D/PV 800
1SDA070492R1	KIT 3JUMPER U 4PS T6D/PV 800
1SDA070429R1	KIT JUMPER U 2+2PS T7D/PV 1250
1SDA070431R1	KIT JUMPER U 2+2PS T7D/PV 1600
1SDA070430R1	KIT JUMPER U 4PS T7D/PV 1250
1SDA070432R1	KIT JUMPER U 4PS T7D/PV 1600

Tmax PV can be accessoried with Tmax T series accessories, except for the following exceptions.

Frame size	Incompatibilities
T1D PV	Interlocks, KLC, PLL
T3D PV	Interlocks, KLC, PLL
T4D PV	Interlocks
T5D PV	Interlocks
T6D PV	Interlocks
T7D PV	Interlocks
T7D PV M	Interlocks

Accessories part number, wirings and data can be found in the Tmax T IEC technical catalog code 1SDC210015D0208.

Wire options Tmax PV - IEC	
Code	Description
1SDA051482R1	FcCu T3 1x185mm ² 3pcs
1SDA051483R1	FcCu T3 1x185mm ² 4pcs
1SDA053696R1	FcCuAl 1x150mm ² T3 3pcs
1SDA053697R1	FcCuAl 1x150mm ² T3 4pcs
1SDA054980R1	FcCu T4 1x185mm ² 3pcs
1SDA054981R1	FcCu T4 1x185mm ² 4pcs
1SDA054988R1	FcCuAl T4 1x185mm ² 3pcs
1SDA054989R1	FcCuAl T4 1x185mm ² 4pcs
1SDA055364R1	FcCu T5 2x185mm ² 3pcs
1SDA055365R1	FcCu T5 2x185mm ² 4pcs
1SDA055032R1	FcCuAl T5 2x240mm ² 3pcs
1SDA055033R1	FcCuAl T5 2x240mm ² 4pcs
1SDA023380R1	FcCuAl T6 2x240mm ² 3pcs
1SDA023390R1	FcCuAl T6 2x240mm ² 4pcs
1SDA063112R1	FcCuAl T7 4x240mm ² 3pcs
1SDA063113R1	FcCuAl T7 4x240mm ² 4pcs

UL range ordering codes

Switch-Disconnecter	
Code	Description
1SDA070004R1	T1N-D/PV 100 MCS UL 4p F FC Cu 1000V DC
1SDA070460R1	T4N-D/PV 200 MCS UL 3p F F 1000V DC
1SDA070471R1	T5N-D/PV 400 MCS UL 3p F F 1000V DC
1SDA070493R1	T6N-D/PV 600 MCS UL 4p F F 1000V DC
1SDA070494R1	T6N-D/PV 800 MCS UL 4p F F 1000V DC
1SDA070448R1	T7N-D/PV 1000 MCS UL 4p F F M 1000V DC
1SDA082657R1	T7N-D/PV-E 1000 MCS UL 4p F F M 1500V DC
1SDA082915R1	T7N-D/PV-E 1200 MCS UL 4p F F M 1500V DC

Circuit-breaker	
Code	Description
1SDA070461R1	T4N/PV 200 UL TMD 40 3p F F 1000V DC
1SDA070462R1	T4N/PV 200 UL TMD 50 3p F F 1000V DC
1SDA070463R1	T4N/PV 200 UL TMA 80-800 3p F F 1000V DC
1SDA070467R1	T4N/PV 200 UL TMA 100-1000 3p FF 1000V DC
1SDA070468R1	T4N/PV 200 UL TMA 125-1250 3p FF 1000V DC
1SDA070469R1	T4N/PV 200 UL TMA 150-1500 3p FF 1000V DC
1SDA070470R1	T4N/PV 200 UL TMA 200-2000 3p FF 1000V DC
1SDA079819R1	T5N/PV 250 UL TMD 1500-3000 3p FF 1000V DC
1SDA079820R1	T5N/PV 225 UL TMD 1500-3000 3p FF 1000V DC
1SDA079818R1	T5N/PV 300 UL TMD 1500-3000 3p FF 1000V DC
1SDA070472R1	T5N/PV 400 UL TMA 400-4000 3p FF 1000V DC
1SDA070495R1	T6N/PV 800 UL TMA 600-6000 4p FF 1000V DC
1SDA070496R1	T6N/PV 800 UL TMA 800-8000 4p FF 1000V DC

Kit Jumpers	
Code	Description
1SDA070424R1	KIT 2 JUMPER 2+2PS T1N-D/PV-B 100 UL 4p
1SDA070425R1	KIT 3 JUMPER 4PS T1N-D/PV-A 100 UL 4p
1SDA070483R1	KIT 1 JUMPER 2+1PS T4N/PV-B 100A UL 3p
1SDA070484R1	KIT 1 JUMPER 2+1PS T4 PV-B 200A UL 3p
1SDA070485R1	KIT 2 JUMPER 3PS T4N/PV-A 100A UL 3p
1SDA070486R1	KIT 2 JUMPER 3PS T4 PV-A 200A UL 3p
1SDA070487R1	KIT 1 JUMPER 2+1PS T5 PV-B 400 UL 3p cables
1SDA070488R1	KIT 2 JUMPER 3PS T5 PV-A 400 UL 3p cables
1SDA074504R1	KIT 1 JUMPER 2+1PS T5 PV-B 400 UL 3p busbars
1SDA074505R1	KIT 2 JUMPER 3PS T5 PV-A 400 UL 3p busbars
1SDA079821R1	KIT 1 JUMPER 2+1PS T5 PV-B 225 UL 3p
1SDA079823R1	KIT 1 JUMPER 2+1PS T5 PV-B 250 UL 3p
1SDA079824R1	KIT 2 JUMPER 3PS T5 PV-A 225 UL 3p
1SDA079825R1	KIT 2 JUMPER 3PS T5 PV-A 250 UL 3p
1SDA070499R1	KIT 2 JUMPER 2+2PS T6 PV-B 600 UL 4p
1SDA070500R1	KIT 3 JUMPER 4PS T6 PV-A 600 UL 4p
1SDA070501R1	KIT 2 JUMPER 2+2PS T6 PV-B 800 UL 4p
1SDA070502R1	KIT 3 JUMPER 4PS T6 PV-A 800 UL 4p
1SDA070451R1	KIT 2 JUMPER 2+2PS T7N-D/PV-B 1000 UL 4p cables
1SDA070452R1	KIT 3 JUMPER U 4PS T7N-D/PV-A 1000 UL 4p cables
1SDA081762R1	KIT 2 JUMPER 2+2PS T7N-D/PV-B 1000 UL 4p busbars
1SDA081763R1	KIT 3 JUMPER U 4PS T7N-D/PV-A 1000 UL 4p busbars
1SDA083038R1	KIT 2JUMPER 2+2PS T7N-D/PV1200 UL Term.F
1SDA083039R1	KIT 3JUMPER U 4PS T7N-D/PV1200 UL Term.F

Tmax PV can be accessoried with Tmax T series accessories, except for the following exceptions.

Frame size	Incompatibilities
T1D PV	Interlocks, KLC, PLL
T3D PV	Interlocks, KLC, PLL
T4D PV	Interlocks
T5D PV	Interlocks
T6D PV	Interlocks
T7D PV	Interlocks
T7D PV M	Interlocks

Accessories part number, wirings and data can be found in the Tmax T UL489 1SDC210023D0201 technical catalog.

800V AC IEC and UL ranges ordering codes

IEC range ordering codes	
Code	Description
1SDA083647R1	T4V-HA250 TMA80-800 4p FF 800V AC
1SDA083648R1	T4V-HA250 TMA100-1000 4p FF800V AC
1SDA083649R1	T4V-HA250 TMA125-1250 4p FF 800V AC N100%
1SDA083650R1	T4V-HA250 TMA160-1600 4p FF 800V AC N100%
1SDA083651R1	T4V-HA250 TMA200-2000 4p FF 800V AC N100%
1SDA083652R1	T4V-HA250 TMA250-2500 4p FF 800V AC N100%
1SDA083653R1	T5V-HA400 TMA320-3200 4p FF 800V AC N100%
1SDA083654R1	T5V-HA400 TMA400-4000 4p FF 800V AC N100%
1SDA083655R1	T5V-HA630 TMA500-5000 4p FF 800V AC N100%
1SDA083658R1	T4V-HA 250 TMA 80-800 3p FF 800V AC
1SDA083659R1	T4V-HA 250 TMA 100-1000 3p FF 800V AC
1SDA083660R1	T4V-HA 250 TMA 125-1250 3p FF 800V AC
1SDA083661R1	T4V-HA 250 TMA 160-1600 3p FF 800V AC
1SDA083662R1	T4V-HA 250 TMA 200-2000 3p FF 800V AC
1SDA083663R1	T4V-HA 250 TMA 250-2500 3p FF 800V AC
1SDA083664R1	T5V-HA 400 TMA 320-3200 3p FF 800V AC
1SDA083665R1	T5V-HA 400 TMA 400-4000 3p FF 800V AC
1SDA083666R1	T5V-HA 630 TMA 500-5000 3p FF 800V AC
1SDA083666R1	T5V-HA630 PR221DS-LS/I In630 3p FF 800V AC
1SDA083667R1	T5V-HA630 PR221DS-LS/I In630 4p FF800V AC

NOTE: High Terminal Covers are mandatory for top and bottom and already included in the circuit-breakers ordering codes

UL range ordering codes		
Code	Description	UL rated
1SDA083668R1	T4V-HA250 UL TMA80-800 4p FF 800V AC	100%
1SDA083669R1	T4V-HA250 UL TMA100-1000 4p FF800V AC	100%
1SDA083670R1	T4V-HA250 UL TMA125-1250 4p FF 800V AC	100%
1SDA083671R1	T4V-HA250 UL TMA150-1500 4p FF 800V AC	100%
1SDA083672R1	T4V-HA250 UL TMA200-2000 4p FF 800V AC	80%
1SDA083673R1	T4V-HA250 UL TMA80-800 3p FF 800V AC	100%
1SDA083674R1	T4V-HA250 UL TMA100-1000 3p FF800V AC	100%
1SDA083675R1	T4V-HA250 UL TMA125-1250 3p FF 800V AC	100%
1SDA083676R1	T4V-HA250 UL TMA150-1500 3p FF 800V AC	100%
1SDA083677R1	T4V-HA250 UL TMA200-2000 3p FF 800V AC	80%
1SDA083678R1	T5V-HA400 UL TMA 300-3000 3p FF 800V AC	100%
1SDA083679R1	T5V-HA400 UL TMA300-3000 4p FF 800V AC	100%
1SDA083680R1	T5V-HA400UL PR221DS-LS/I In300 3p FF 800V AC	100%
1SDA083681R1	T5V-HA400UL PR221DS-LS/I In300 4p FF 800V AC	100%

NOTE: High Terminal Covers are mandatory for top and bottom and already included in the circuit-breakers ordering codes

Wire options Tmax PV - IEC/UL

Code	Description
1SDA054988R1	FcCuAL T4 3pcs 1x350kcmil
1SDA054989R1	FcCuAL T4 4pcs 1x350kcmil
1SDA055020R1	FcCuAL T5 3pcs 1x500kcmil
1SDA055021R1	FcCuAL T5 4pcs 1x500kcmil
1SDA054980R1	FcCu T4 1x185mm ² 3pcs
1SDA054981R1	FcCu T4 1x185mm ² 4pcs
1SDA054988R1	FcCuAl T4 1x185mm ² 3pcs
1SDA054989R1	FcCuAl T4 1x185mm ² 4pcs
1SDA055016R1	FcCu T5 1x240mm ² 3pcs
1SDA055017R1	FcCu T5 1x240mm ² 4pcs
1SDA055020R1	FcCuAl T5 1x240mm ² 3pcs
1SDA055021R1	FcCuAl T5 1x240mm ² 4pcs
1SDA055032R1	FcCuAl T5 2x240mm ² 3pcs
1SDA055033R1	FcCuAl T5 2x240mm ² 4pcs

Contact us

ABB SACE

A division of ABB S.p.A.

L.V. Breakers

Via Pescaria, 5

24123 Bergamo - Italy

Phone: +39 035 395.549

Fax: +39 035 395.284

www.abb.com



Stay tuned. Discover more by visiting the webpages reserved to Tmax PV and be always up-to-date with the latest edition of the catalog.