

# APC<sup>®</sup> Battery Cartridge Replacement

by Schneider Electric

Recycle



For information on recycling the used battery, see the Used Battery Information sheet included with the replacement battery.

## Back-UPS

### BN1250LCD

BR1000-CH, BR1100CI, BR1100CI-RS, BR1100CI-AS, BR1100CI-IN, BR1200LCDI,  
BR1300LCD, BR1500LCD, BR1500LCDI

BX900R, BX1200R, BX1300LCD, BX1300LCD-CN, BX1500LCD

### DL1000VNT

- 1 PRESS RELEASE TABS AND SLIDE OFF BATTERY DOOR.

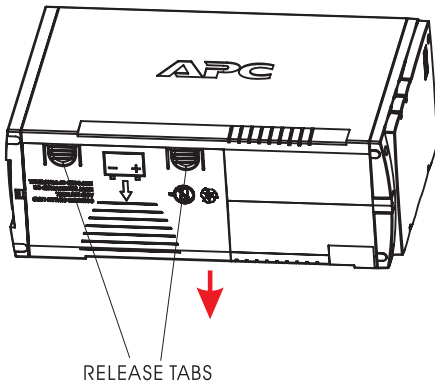

- 2 DISCONNECT THE BATTERY WIRES.

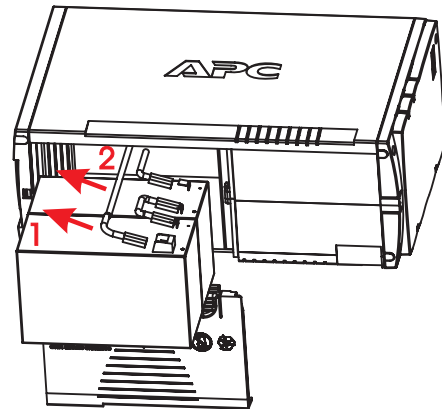

- 3 REPLACE THE NEW BATTERY AND CONNECT THE WIRES.

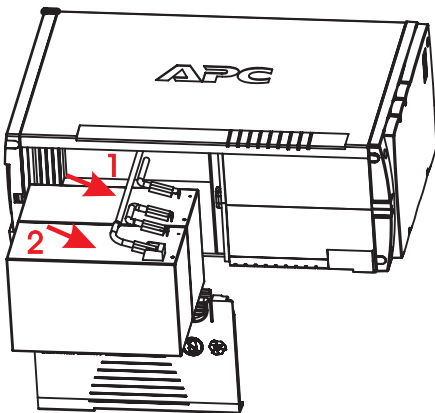

- 4 CLOSE THE BATTERY DOOR.

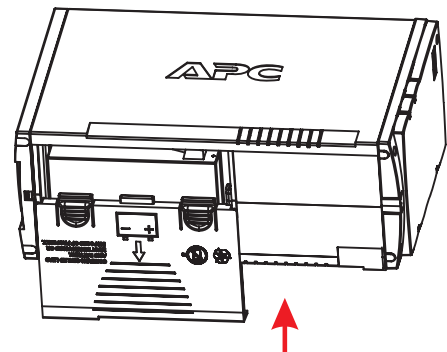

**Back-UPS BK 200/500**  
**Back-UPS Pro**  
**Smart-UPS SU 280/420**

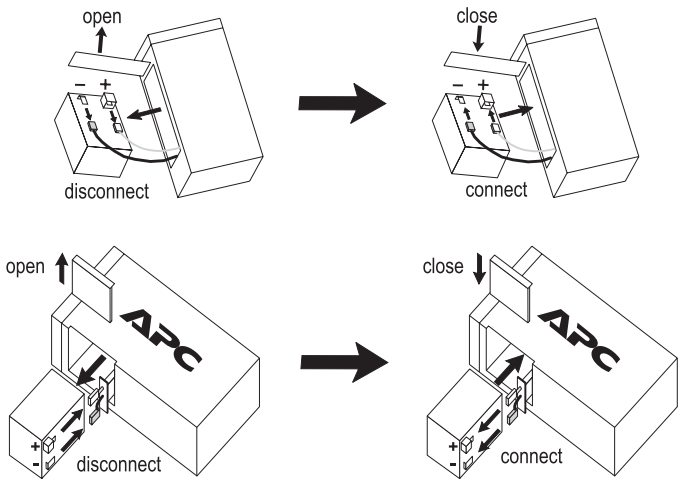

**Back-UPS Pro USB 350/500/650**

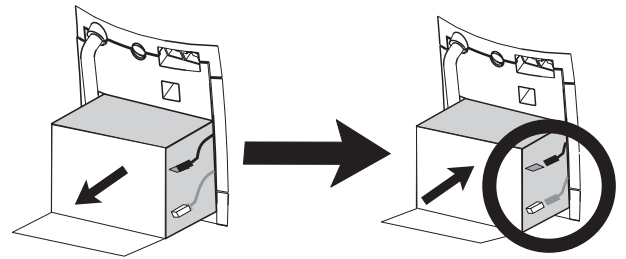

**Back-UPS Office 250/500**

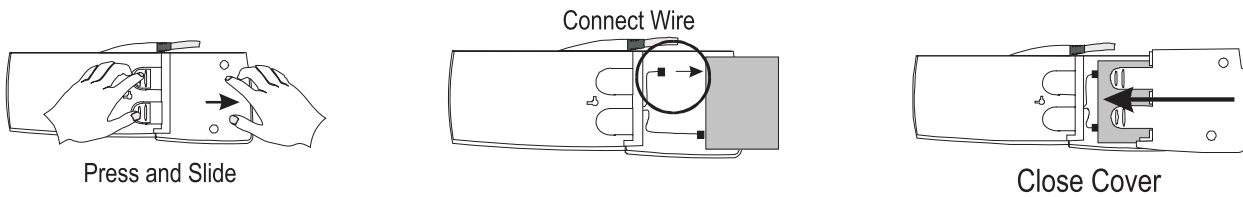

**Back-UPS 1000/1400**

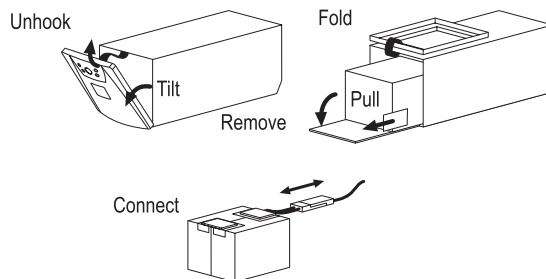

## Back-UPS ES350/ES500

remove screw

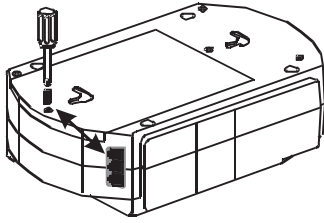

slide cover off

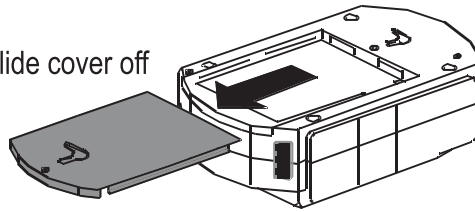

disconnect wires, replace with new battery and reconnect wires.

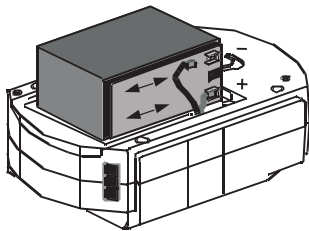

Back-UPS ES 500

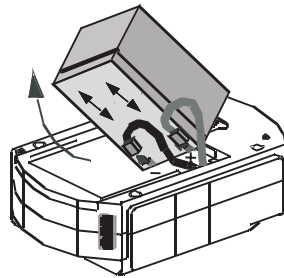

Close cover and  
reinstall screw

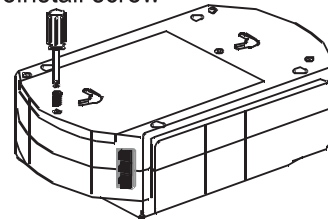

## Back-UPS ES 350/450/550/650/725/750 (120 V)

## Back-UPS ES 400/550/700 (230 V)

press release tabs and slide off cover

disconnect wires, replace with new battery  
and reconnect wires.

close cover

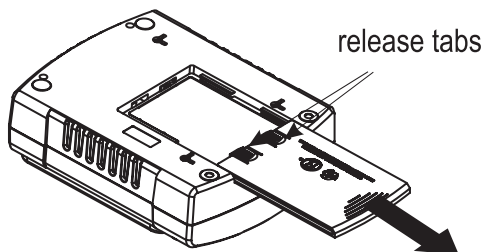

release tabs

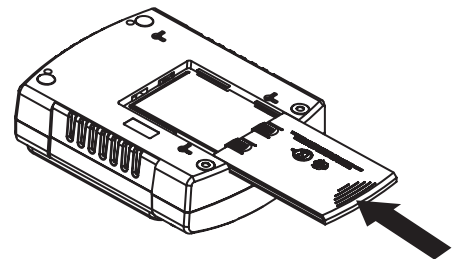
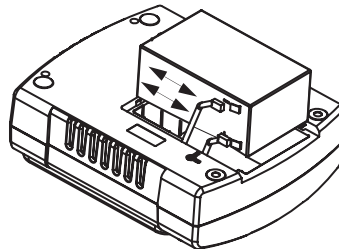

## Smart-UPS Rack-mount (5.25-inch models)

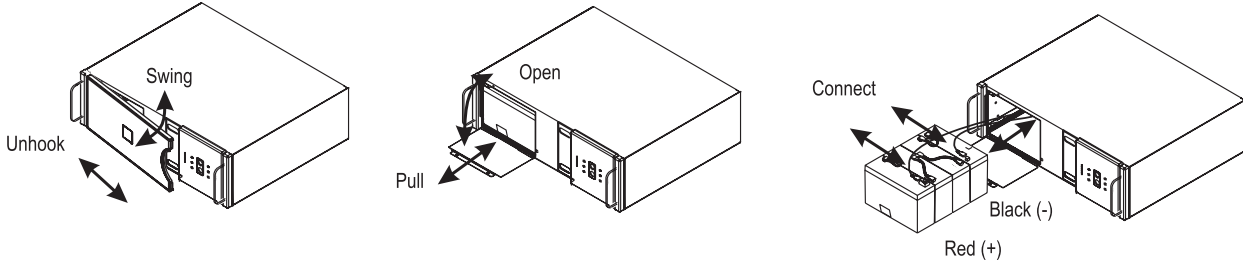

MODELS 700-1400

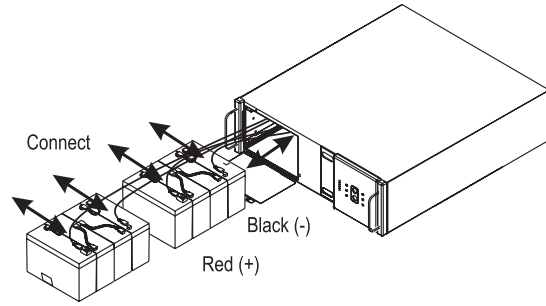

MODELS 2200-3000

## Smart-UPS Rack-mount (8.75-inch models)

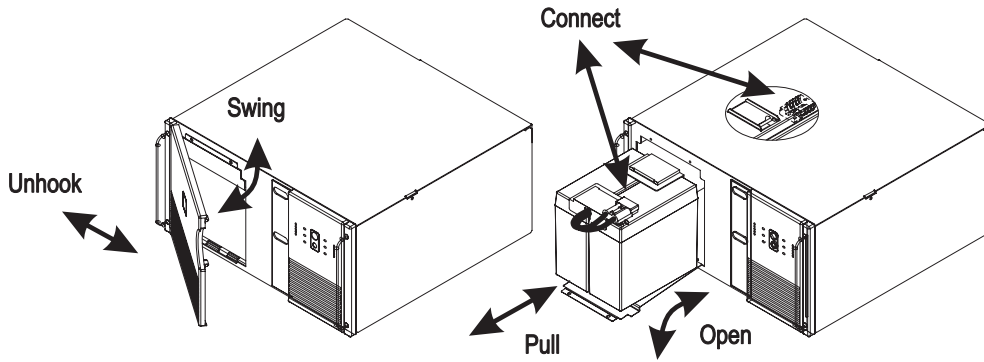

## Smart-UPS Rack-mount XL Battery Packs

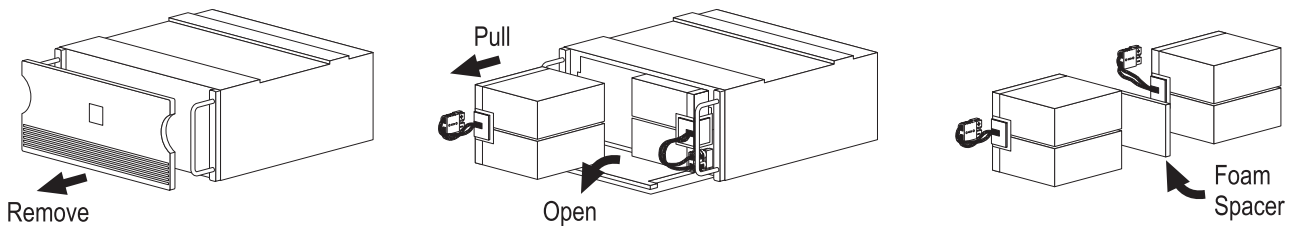

## Smart-UPS 2200/3000

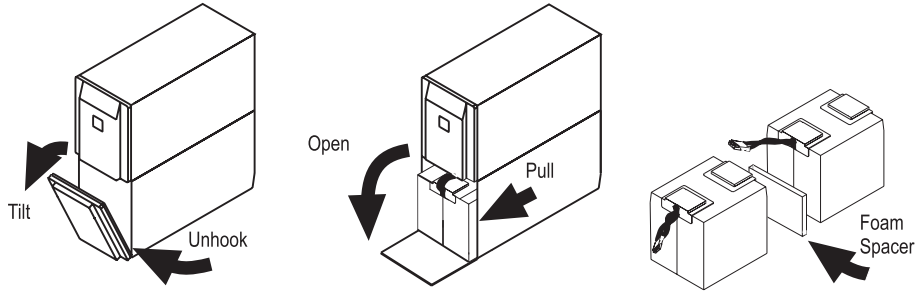

## UXBP 24/48/48M

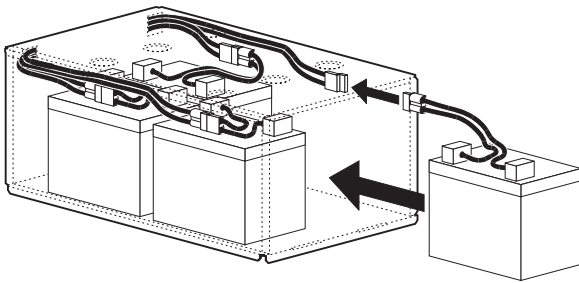

## SmartCell XR

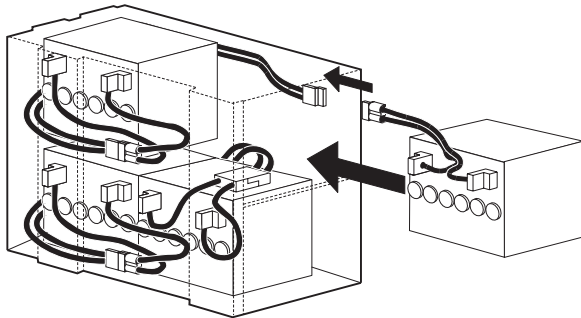

## Smart-UPS 450/1500

## Smart-UPS XLBP

