

# Installation Instructions

Original Instructions



**Allen-Bradley**

by ROCKWELL AUTOMATION

## FLEX I/O Digital Input Modules

Catalog Numbers 1794-IB8, 1794-IB16, 1794-IB32, 1794-IB32K

Topic	Page
Summary of Changes	1
Overview	5
Install Your Module	5
Wire Your Module	5
Configure Your Module	8
Specifications	10
Additional Resources	13

### Summary of Changes

This publication contains the following new or updated information. This list includes substantive updates only and is not intended to reflect all changes.

Topic	Page
Updated Certifications	12
Added Additional Resources	13



**ATTENTION:** Read this document and the documents listed in the Additional Resources section about installation, configuration and operation of this equipment before you install, configure, operate or maintain this product. Users are required to familiarize themselves with installation and wiring instructions in addition to requirements of all applicable codes, laws, and standards.

Activities including installation, adjustments, putting into service, use, assembly, disassembly, and maintenance are required to be carried out by suitably trained personnel in accordance with applicable code of practice. If this equipment is used in a manner not specified by the manufacturer, the protection provided by the equipment may be impaired.

注意：在安装、配置、操作和维护本产品前，请阅读本文档以及“其他资源”部分列出的有关设备安装、配置和操作的相应文档。除了所有适用规范、法律和标准的相关要求之外，用户还必须熟悉安装和接线说明。

安装、调整、投运、使用、组装、拆卸和维护等各项操作必须由经过适当训练的专业人员按照适用的操作规范实施。

如果未按照制造商指定的方式使用该设备，则可能会损害设备提供的保护。

**ATENCIÓN:** Antes de instalar, configurar, poner en funcionamiento o realizar el mantenimiento de este producto, lea este documento y los documentos listados en la sección Recursos adicionales acerca de la instalación, configuración y operación de este equipo. Los usuarios deben familiarizarse con las instrucciones de instalación y cableado y con los requisitos de todos los códigos, leyes y estándares vigentes.

El personal debidamente capacitado debe realizar las actividades relacionadas a la instalación, ajustes, puesta en servicio, uso, ensamblaje, desensamblaje y mantenimiento de conformidad con el código de práctica aplicable. Si este equipo se usa de una manera no especificada por el fabricante, la protección provista por el equipo puede resultar afectada.

**ATENÇÃO:** Leia este e os demais documentos sobre instalação, configuração e operação do equipamento que estão na seção Recursos adicionais antes de instalar, configurar, operar ou manter este produto. Os usuários devem se familiarizar com as instruções de instalação e fiação além das especificações para todos os códigos, leis e normas aplicáveis.

É necessário que as atividades, incluindo instalação, ajustes, colocação em serviço, utilização, montagem, desmontagem e manutenção sejam realizadas por pessoal qualificado e especializado, de acordo com o código de prática aplicável.

Caso este equipamento seja utilizado de maneira não estabelecida pelo fabricante, a proteção fornecida pelo equipamento pode ficar prejudicada.

**ВНИМАНИЕ:** Перед тем как устанавливать, настраивать, эксплуатировать или обслуживать данное оборудование, прочитайте этот документ и документы, перечисленные в разделе «Дополнительные ресурсы». В этих документах изложены сведения об установке, настройке и эксплуатации данного оборудования. Пользователи обязаны ознакомиться с инструкциями по установке и прокладке соединений, а также с требованиями всех применимых норм, законов и стандартов.

Все действия, включая установку, наладку, ввод в эксплуатацию, использование, сборку, разборку и техническое обслуживание, должны выполняться обученным персоналом в соответствии с применимыми нормами и правилами.

Если оборудование используется не предусмотренным производителем образом, защита оборудования может быть нарушена.

注意：本製品を設置、構成、稼動または保守する前に、本書および本機器の設置、設定、操作についての参考資料の該当箇所に記載されている文書に目を通してください。ユーザは、すべての該当する条例、法律、規格の要件に加えて、設置および配線の手順に習熟している必要があります。

設置調整、運転の開始、使用、組立て、解体、保守を含む諸作業は、該当する実施規則に従って訓練を受けた適切な作業員が実行する必要があります。

本機器が製造メーカーにより指定されていない方法で使用されている場合、機器により提供されている保護が損なわれる恐れがあります。

**ACHTUNG:** Lesen Sie dieses Dokument und die im Abschnitt „Weitere Informationen“ aufgeführten Dokumente, die Informationen zu Installation, Konfiguration und Bedienung dieses Produkts enthalten, bevor Sie dieses Produkt installieren, konfigurieren, bedienen oder warten. Anwender müssen sich neben den Bestimmungen aller anwendbaren Vorschriften, Gesetze und Normen zusätzlich mit den Installations- und Verdrahtungsanweisungen vertraut machen.

Arbeiten im Rahmen der Installation, Anpassung, Inbetriebnahme, Verwendung, Montage, Demontage oder Instandhaltung dürfen nur durch ausreichend geschulte Mitarbeiter und in Übereinstimmung mit den anwendbaren Ausführungsvorschriften vorgenommen werden.

Wenn das Gerät in einer Weise verwendet wird, die vom Hersteller nicht vorgesehen ist, kann die Schutzfunktion beeinträchtigt sein.

**ATTENTION :** Lisez ce document et les documents listés dans la section Ressources complémentaires relatifs à l'installation, la configuration et le fonctionnement de cet équipement avant d'installer, configurer, utiliser ou entretenir ce produit. Les utilisateurs doivent se familiariser avec les instructions d'installation et de câblage en plus des exigences relatives aux codes, lois et normes en vigueur. Les activités relatives à l'installation, le réglage, la mise en service, l'utilisation, l'assemblage, le démontage et l'entretien doivent être réalisées par des personnes formées selon le code de pratique en vigueur.

Si cet équipement est utilisé d'une façon qui n'a pas été définie par le fabricant, la protection fournie par l'équipement peut être compromise.

주의：본 제품 설치, 설정, 작동 또는 유지 보수하기 전에 본 문서를 포함하여 설치, 설정 및 작동에 관한 참고 자료 섹션의 문서들을 반드시 읽고 숙지하십시오. 사용자는 모든 관련 규정, 법규 및 표준에서 요구하는 사항에 대해 반드시 설치 및 배선 지침을 숙지해야 합니다.

설치, 조정, 가동, 사용, 조립, 분해, 유지보수 등 모든 작업은 관련 규정에 따라 적절한 교육을 받은 사용자가 통해서만 수행해야 합니다.

본 장비를 제조사가 명시하지 않은 방법으로 사용하면 장비의 보호 기능이 손상될 수 있습니다.

**ATTENZIONE** Prima di installare, configurare ed utilizzare il prodotto, o effettuare interventi di manutenzione su di esso, leggere il presente documento ed i documenti elencati nella sezione "Altre risorse", riguardanti l'installazione, la configurazione ed il funzionamento dell'apparecchiatura. Gli utenti devono leggere e comprendere le istruzioni di installazione e cablaggio, oltre ai requisiti previsti dalle leggi, codici e standard applicabili.

Le attività come installazione, regolazioni, utilizzo, assemblaggio, disassemblaggio e manutenzione devono essere svolte da personale adeguatamente addestrato, nel rispetto delle procedure previste. Qualora l'apparecchio venga utilizzato con modalità diverse da quanto previsto dal produttore, la sua funzione di protezione potrebbe venire compromessa.

**DIKKAT:** Bu ürünün kurulumu, yapılandırılması, işletilmesi veya bakımı öncesinde bu dokümanı ve bu ekipmanın kurulumu, yapılandırılması ve işletimi ile ilgili ilave Kaynaklar bölümünde yer listelenmiş dokümanları okuyun. Kullanıcılar yürürlükteki tüm yönetmelikler, yasalar ve standartların gereksinimlerine ek olarak kurulum ve kablolama talimatlarını da öğrenmek zorundadır.

Kurulum, ayarlama, hizmete alma, kullanma, parçaları birleştirme, parçaları sökme ve bakım gibi aktiviteler sadece uygun eğitimleri almış kişiler tarafından yürürlükteki uygulama yönetmeliklerine uygun şekilde yapılabilir.

Bu ekipman üretici tarafından belirlenmiş amacın dışında kullanılırsa, ekipman tarafından sağlanan koruma bozulabilir.

注意事項：在安装、設定、操作或維護本產品前，請先閱讀此文件以及列於「其他資源」章節中有關安裝、設定與操作此設備的文件。使用者必須熟悉安裝和配線指示，並符合所有法規、法律和標準要求。

包括安裝、調整、交付使用、使用、組裝、拆卸和維護等動作都必須交由已經適當訓練的人員進行，以符合適用的實作法規。

如果將設備用於非製造商指定的用途時，可能會造成設備所提供的保護功能受損。

**POZOR:** Než začnete instalovat, konfigurovat či provozovat tento výrobek nebo provádět jeho údržbu, přečtěte si tento dokument a dokumenty uvedené v části Dodatečné zdroje ohledně instalace, konfigurace a provozu tohoto zařízení. Uživatelé se musejí vedle požadavků všech relevantních vyhlášek, zákonů a norem nutně seznámit také s pokyny pro instalaci a elektrické zapojení.

Činnosti zahrnující instalaci, nastavení, uvedení do provozu, užívání, montáž, demontáž a údržbu musí vykonávat vhodně proškolený personál v souladu s příslušnými prováděcími předpisy.

Pokud se toto zařízení používá způsobem neodpovídajícím specifikaci výrobce, může být narušena ochrana, kterou toto zařízení poskytuje.

**UWAGA:** Przed instalacją, konfiguracją, użytkowaniem lub konserwacją tego produktu należy przeczytać niniejszy dokument oraz wszystkie dokumenty wymienione w sekcji Dodatkowe źródła omawiające instalację, konfigurację i procedury użytkowania tego urządzenia. Użytkownicy mają obowiązek zapoznać się z instrukcjami dotyczącymi instalacji oraz oprzewodowania, jak również z obowiązującymi kodeksami, prawem i normami.

Działania obejmujące instalację, regulację, przekazanie do użytkowania, użytkowanie, montaż, demontaż oraz konserwację muszą być wykonywane przez odpowiednio przeszkolony personel zgodnie z obowiązującym kodeksem postępowania.

Jeśli urządzenie jest użytkowane w sposób inny niż określony przez producenta, zabezpieczenie zapewniane przez urządzenie może zostać ograniczone.

**OBES!** Läs detta dokument samt dokumentet, som står listat i avsnittet Övriga resurser, om installation, konfiguration och drift av denna utrustning innan du installerar, konfigurerar eller börjar använda eller utföra underhållsarbete på produkten. Användare måste bekanta sig med instruktioner för installation och kabeldragning, förutom krav enligt gällande koder, lagar och standarder.

Åtgärder som installation, justering, service, användning, montering, demontering och underhållsarbete måste utföras av personal med lämplig utbildning enligt lämpligt bruk.

Om denna utrustning används på ett sätt som inte anges av tillverkaren kan det hända att utrustningens skyddsanordningar försätts ur funktion.

**LET OP:** Lees dit document en de documenten die genoemd worden in de paragraaf Aanvullende informatie over de installatie, configuratie en bediening van deze apparatuur voordat u dit product installeert, configureert, bedient of onderhoudt. Gebruikers moeten zich vertrouwd maken met de installatie en de bedringsinstructies, naast de vereisten van alle toepasselijke regels, wetten en normen.

Activiteiten zoals het installeren, afstellen, in gebruik stellen, gebruiken, monteren, demonteren en het uitvoeren van onderhoud mogen uitsluitend worden uitgevoerd door hiervoor opgeleid personeel en in overeenstemming met de geldende praktijkregels.

Indien de apparatuur wordt gebruikt op een wijze die niet is gespecificeerd door de fabrikant, dan bestaat het gevaar dat de beveiliging van de apparatuur niet goed werkt.

---

**Environment and Enclosure**

---



**ATTENTION:** This equipment is intended for use in a Pollution Degree 2 industrial environment, in overvoltage Category II applications (as defined in EN/IEC 60664-1), at altitudes up to 2000 m (6562 ft) without derating. This equipment is not intended for use in residential environments and may not provide adequate protection to radio communication services in such environments.

This equipment is supplied as open-type equipment for indoor use. It must be mounted within an enclosure that is suitably designed for those specific environmental conditions that will be present and appropriately designed to prevent personal injury resulting from accessibility to live parts. The enclosure must have suitable flame-retardant properties to prevent or minimize the spread of flame, complying with a flame spread rating of 5VA or be approved for the application if nonmetallic. The interior of the enclosure must be accessible only by the use of a tool. Subsequent sections of this publication may contain more information regarding specific enclosure type ratings that are required to comply with certain product safety certifications.

In addition to this publication, see the following:

- Industrial Automation Wiring and Grounding Guidelines, publication [1770-4.1](#), for more installation requirements.
  - NEMA Standard 250 and EN/IEC 60529, as applicable, for explanations of the degrees of protection provided by enclosures.
- 

**Prevent Electrostatic Discharge**

---



**ATTENTION:** This equipment is sensitive to electrostatic discharge, which can cause internal damage and affect normal operation. Follow these guidelines when you handle this equipment:

- Touch a grounded object to discharge potential static.
  - Wear an approved grounding wriststrap.
  - Do not touch connectors or pins on component boards.
  - Do not touch circuit components inside the equipment.
  - Use a static-safe workstation, if available.
  - Store the equipment in appropriate static-safe packaging when not in use.
- 

**UK and European Hazardous Location Approval**

---

The following modules are UK and European Zone 2 approved: 1794-IB8, 1794-IB16

**The following applies to products marked  II 3 G:**

- Are Equipment Group II, Equipment Category 3, and comply with the Essential Health and Safety Requirements relating to the design and construction of such equipment given in Schedule 1 of UKEX and Annex II of EU Directive 2014/34/EU. See the UKEx and EU Declaration of Conformity at [rok.auto/certifications](http://rok.auto/certifications) for details.
  - The type of protection is Ex ec IIC T4 Gc (**1794-IB16**) and Ex ec IIC T3 Gc (**1794-IB8**) according to EN IEC 60079-0:2018 and EN IEC 60079-7:2015+A1:2018.
  - Comply with Standards EN IEC 60079-0:2018 & EN IEC 60079-7:2015+A1:2018 reference certificate number DEMKO 14 ATEX 1342501X and UL22UKEX2378X.
  - Are intended for use in areas in which explosive atmospheres caused by gases, vapors, mists, or air are unlikely to occur, or are likely to occur only infrequently and for short periods. Such locations correspond to Zone 2 classification according to UKEX regulation 2016 No. 1107 and ATEX directive 2014/34/EU.
- 

**IEC Hazardous Location Approval**

---

**The following applies to products with IECEx certification:**

- Are intended for use in areas in which explosive atmospheres caused by gases, vapors, mists, or air are unlikely to occur, or are likely to occur only infrequently and for short periods. Such locations correspond to Zone 2 classification to IEC 60079-0.
  - The type of protection is Ex ec IIC T4 Gc (**1794-IB16**) and Ex ec IIC T3 Gc (**1794-IB8**) according to IEC 60079-0 and IEC 60079-7.
  - Comply with Standards IEC 60079-0, Explosive atmospheres Part 0: Equipment - General requirements, Edition 7, Revision Date 2017, IEC 60079-7, 5.1 Edition revision date 2017, Explosive atmospheres - Part 7: Equipment protection by increased safety "e", reference IECEx certificate number IECEx UL 14.0066X.
- 



**WARNING: Special Conditions for Safe Use**

- This equipment shall be mounted in an UKEX/ATEX/IECEx Zone 2 certified enclosure with a minimum ingress protection rating of at least IP54 (in accordance with EN/IEC 60079-0) and used in an environment of not more than Pollution Degree 2 (as defined in EN/IEC 60664-1) when applied in Zone 2 environments. The enclosure must be accessible only by the use of a tool.
  - This equipment shall be used within its specified ratings defined by Rockwell Automation.
  - Transient protection shall be provided that is set at a level not exceeding 140% of the peak rated voltage value at the supply terminals to the equipment.
  - The instructions in the user manual shall be observed.
  - This equipment must be used only with UKEX/ATEX/IECEx certified Rockwell Automation backplanes.
  - Earthing is accomplished through mounting of modules on rail.
- 



**WARNING:** Secure any external connections that mate to this equipment by using screws, sliding latches, threaded connectors, or other means provided with this product. Do not disconnect equipment unless power has been removed or the area is known to be nonhazardous.

---





**WARNING:** When you insert or remove the module while backplane power is on, an electric arc can occur. This could cause an explosion in hazardous location installations.

Be sure that power is removed or the area is nonhazardous before proceeding. Repeated electric arcing causes excessive wear to contacts on both the module and its mating connector. Worn contacts may create electrical resistance that can affect module operation.

---

North American Hazardous Location Approval

The following information applies when operating this equipment in hazardous locations.	Informations sur l'utilisation de cet équipement en environnements dangereux.
<p>Products marked "CL I, DIV 2, GP A, B, C, D" are suitable for use in Class I Division 2 Groups A, B, C, D, Hazardous Locations and nonhazardous locations only. Each product is supplied with markings on the rating nameplate indicating the hazardous location temperature code. When combining products within a system, the most adverse temperature code (lowest "T" number) may be used to help determine the overall temperature code of the system. Combinations of equipment in your system are subject to investigation by the local Authority Having Jurisdiction at the time of installation.</p>	<p>Les produits marqués "CL I, DIV 2, GP A, B, C, D" ne conviennent qu'à une utilisation en environnements de Classe I Division 2 Groupes A, B, C, D dangereux et non dangereux. Chaque produit est livré avec des marquages sur sa plaque d'identification qui indiquent le code de température pour les environnements dangereux. Lorsque plusieurs produits sont combinés dans un système, le code de température le plus défavorable (code de température le plus faible) peut être utilisé pour déterminer le code de température global du système. Les combinaisons d'équipements dans le système sont sujettes à inspection par les autorités locales qualifiées au moment de l'installation.</p>
 <p><b>WARNING:</b> <b>Explosion Hazard -</b></p> <ul style="list-style-type: none"> <li>Do not disconnect equipment unless power has been removed or the area is known to be nonhazardous.</li> <li>Do not disconnect connections to this equipment unless power has been removed or the area is known to be nonhazardous. Secure any external connections that mate to this equipment by using screws, sliding latches, threaded connectors, or other means provided with this product.</li> <li>Substitution of components may impair suitability for Class I Division 2.</li> </ul>	 <p><b>AVERTISSEMENT:</b> <b>Risque d'Explosion -</b></p> <ul style="list-style-type: none"> <li>Couper le courant ou s'assurer que l'environnement est classé non dangereux avant de débrancher l'équipement.</li> <li>Couper le courant ou s'assurer que l'environnement est classé non dangereux avant de débrancher les connecteurs. Fixer tous les connecteurs externes reliés à cet équipement à l'aide de vis, loquets coulissants, connecteurs filetés ou autres moyens fournis avec ce produit.</li> <li>La substitution de composants peut rendre cet équipement inadapté à une utilisation en environnement de Classe I Division 2.</li> </ul>

	<p><b>ATTENTION:</b></p> <ul style="list-style-type: none"> <li>If this equipment is used in a manner not specified by the manufacturer, the protection provided by the equipment may be impaired.</li> <li>Read this document and the documents listed in the Additional Resources section about installation, configuration, and operation of this equipment before you install, configure, operate, or maintain this product. Users are required to familiarize themselves with installation and wiring instructions in addition to the requirements of all applicable codes, laws, and standards.</li> <li>Installation, adjustments, putting into service, use, assembly, disassembly, and maintenance are required to be carried out by suitably trained personnel in accordance with the applicable code of practice.</li> <li>In case of malfunction or damage, no attempts at repair should be made. The module should be returned to the manufacturer for repair. Do not dismantle the module.</li> <li>This equipment is certified for use only within the surrounding air temperature range of -20...+55 °C (-4...+131 °F) (<b>1794-IB8 and 1794-IB16</b>) or 0...55 °C (32...131 °F) (<b>1794-IB32, 1794-IB32K</b>). The equipment must not be used outside of this range.</li> <li>Use only a soft dry anti-static cloth to wipe down equipment. Do not use any cleaning agents.</li> </ul>
---	---

	<p><b>ATTENTION:</b> This product is grounded through the DIN rail to chassis ground. Use zinc-plated chromate-passivated steel DIN rail to assure proper grounding. The use of other DIN rail materials (for example, aluminum or plastic) that can corrode, oxidize, or are poor conductors, can result in improper or intermittent grounding. Secure DIN rail to the mounting surface approximately every 200 mm (7.8 in.) and use end-anchors appropriately. Be sure to ground the DIN rail properly. See the Industrial Automation Wiring and Grounding Guidelines, Rockwell Automation publication <a href="#">1770-4.1</a>, for more information.</p>
---	--

	<p><b>ATTENTION:</b> Do not remove or replace a Terminal Base unit while power is applied. Interruption of the backplane can result in unintentional operation or machine motion.</p>
---	---

	<p><b>ATTENTION:</b> : If you connect or disconnect wiring while the field-side power is on, an electric arc can occur. This could cause an explosion in hazardous location installations. Be sure that power is removed or the area is nonhazardous before proceeding.</p>
---	---

Compatibility

The following communication adapters are required to ensure compatibility with the 1794-IB32 and 1794-IB32K:

Remote I/O	1794-ASB Series E or later 1794-ASB2 Series D or later
ControlNet®	1794-ACN15 Series C, firmware revision 4.1 or later 1794-ACNR15 Series C, firmware revision 4.1 or later
DeviceNet®	1794-ADN Series B, firmware revision 2.4 or later for out-of-box compatibility
EtherNet/IP™	1794-AENT Series A, firmware revision 2.4 or later
PROFIBUS	1794-APBDPV1 Series B of the GSD file You can download the GSD file at <a href="http://rok.auto/pcdc">rok.auto/pcdc</a>
ControlLogix® Family	Studio 5000 Logix Designer® application <sup>(1)</sup> version 20 or later

(1) The Studio 5000 Logix Designer application is the rebranding of RSLogix 5000® software and will continue to be the product to program Logix 5000® controllers for discrete, process, batch, motion, safety, and drive-based solutions.

## Overview

The FLEX™ I/O Digital Input module mounts on a 1794 terminal base.

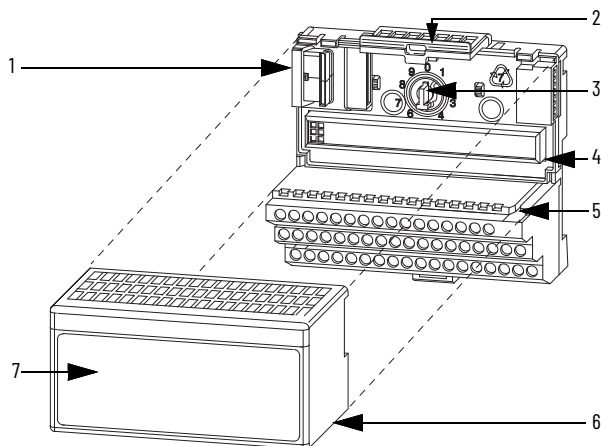

	Description		Description
1	Flexbus connector	5	Groove
2	Latching mechanism	6	Alignment bar
3	Keyswitch	7	Module
4	Terminal base		

## Install Your Module



**ATTENTION:** During mounting of all devices, be sure that all debris (metal chips, wire strands, and so on) is kept from falling into the module. Debris that falls into the module could cause damage on power-up.

1. Rotate the keyswitch (3) on the terminal base (4) clockwise to position 2 as required for this type of module.
2. Make sure the Flexbus connector (1) is pushed all the way to the left to connect with the neighboring terminal base or adapter. **You cannot install the module unless the connector is fully extended.**
3. Make sure the pins on the bottom of the module are straight so they align properly with the connector in the terminal base.
4. Position the module (7) with its alignment bar (6) aligned with the groove (5) on the terminal base.
5. Press firmly and evenly to seat the module in the terminal base unit. The module is seated when the latching mechanism (2) is locked into the module.

## Wire Your Module

### Connect Wiring for 1794-IB8 and 1794-IB16

1. Connect individual input wiring to the numbered terminals on the 0...15 row (A) as indicated in [Table 1](#).
2. Connect the associated +V DC power lead of the input device to the corresponding terminal on the 34...51 row (C) for each input as indicated in [Table 1](#). The +V power terminals of row (C) are internally connected together.
3. Connect the associated input common (3-wire devices only) to the corresponding terminal on the 16...33 row (B) for each input as indicated in [Table 1](#). Commons are internally connected together.
4. Connect +V DC power to terminal 34 on the 34...51 row (C).
5. Connect DC common to terminal 16 on the 16...33 row (B).
6. If daisy chaining power to the next terminal base, connect a jumper from terminal 51 (+V DC) on this base unit to terminal 34 on the next base unit.
7. If continuing DC common to the next terminal base, connect a jumper from terminal 33 (common) on this base unit to terminal 16 on the next base unit.

Figure 1 - Connect Wiring for 1794-TB3 and 1794-TB3S

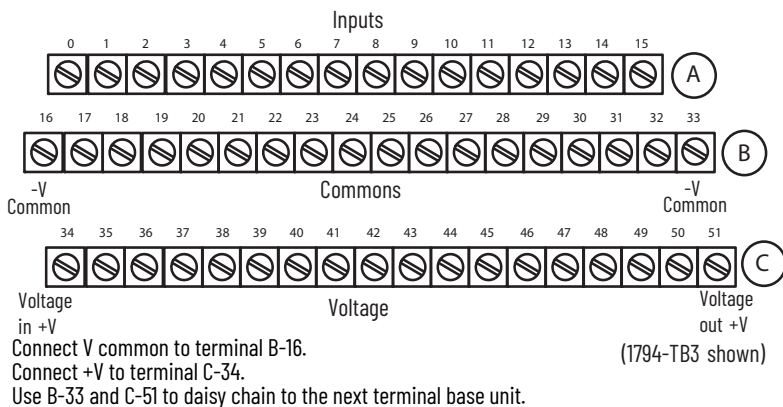
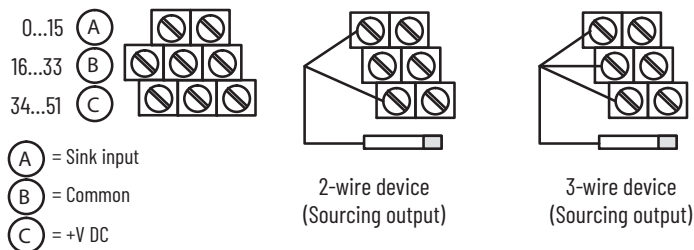

Table 1 - Wiring Connections for the 1794-IB8 and 1794-IB16 Modules  
(Use with a 1794-TB3 or 1794-TB3S Terminal Base)

Input <sup>(1)</sup>	Input Terminal	Voltage Terminal	Common Terminal <sup>(2)</sup>
Input 0	A-0	C-35	B-17
Input 1	A-1	C-36	B-18
Input 2	A-2	C-37	B-19
Input 3	A-3	C-38	B-20
Input 4	A-4	C-39	B-21
Input 5	A-5	C-40	B-22
Input 6	A-6	C-41	B-23
Input 7	A-7	C-42	B-24
Input 8	A-8	C-43	B-25
Input 9	A-9	C-44	B-26
Input 10	A-10	C-45	B-27
Input 11	A-11	C-46	B-28
Input 12	A-12	C-47	B-29
Input 13	A-13	C-48	B-30
Input 14	A-14	C-49	B-31
Input 15	A-15	C-50	B-32
+V DC	C-34...C-51		
Common	B-16...B-33		

(1) 1794-IB8 - Inputs 0...7; 1794-IB16 - Inputs 0...15  
 (2) 3-wire devices use signal, supply, and common. 2-wire devices use signal and supply.

Figure 2 - 2-wire and 3-wire Input Wiring for the 1794-IB8 and 1794-IB16 Modules



## Connect Wiring for 1794-IB32 and 1794-IB32K



**WARNING:** When used in a Class I Division 2, hazardous location, this equipment must be mounted in a suitable enclosure with proper wiring method that complies with the governing electrical codes.

1. Connect individual input wiring (Input 0...15) to numbered terminals on the 0...15 row (A) as indicated in [Table 2](#).
2. Connect the associated power to the +V1 terminal (35, 37, 39, or 41) on the 34...51 row (C) as indicated in [Table 2](#).
3. Connect the associated common for Input 0...15 to COM1 (terminal 36, 38, 40, or 42) on the 34...51 row (C) as indicated in [Table 2](#).
4. Connect individual input wiring (Input 16...31) to numbered terminals on the 16...33 row (B) as indicated in [Table 2](#). **Do not connect to terminals 16 or 33.**
5. Connect the associated power to the +V2 terminal (43, 45, 47, or 49) on the 34...51 row (C) as indicated in [Table 2](#).
6. Connect the associated common for Input 16...31 to COM2 (terminal 44, 46, 48, or 50) on the 34...51 row (C).
7. If continuing input wiring power for Input 0...15 to the next terminal base, connect a jumper from terminal 41 (+V1) on this base unit to the power terminal on the next base unit. See the installation instructions for the specific terminal base.
8. If continuing input wiring common for Input 0...15 to the next terminal base, connect a jumper from terminal 42 (COM1) on this base unit to the common terminal on the next base unit.
9. If continuing input wiring power for Input 16...31 to the next terminal base, connect a jumper from terminal 49 (+V2) on this base unit to the power terminal on the next base unit. See the installation instructions for the specific terminal base.
10. If continuing input wiring common Input 16...31 to the next terminal base, connect a jumper from terminal 50 (COM2) on this base unit to the common terminal on the next base unit.

**Figure 3 - Connect Wiring for 1794-TB32 and 1794-TB32S**

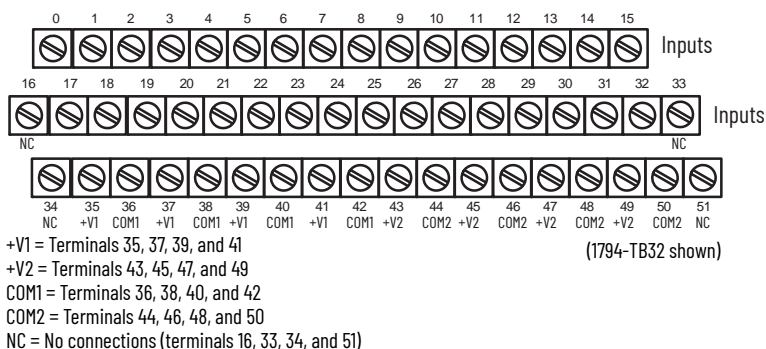

**Table 2 - Wiring Connections for the 1794-IB32 and 1794-IB32K Modules**  
(Use with a 1794-TB32 or 1794-TB32S Terminal Base)

Input <sup>(1)</sup>	Signal	Input	Signal
Input 0	A-0	Input 16	B-17
Input 1	A-1	Input 17	B-18
Input 2	A-2	Input 18	B-19
Input 3	A-3	Input 19	B-20
Input 4	A-4	Input 20	B-21
Input 5	A-5	Input 21	B-22
Input 6	A-6	Input 22	B-23
Input 7	A-7	Input 23	B-24
Input 8	A-8	Input 24	B-25
Input 9	A-9	Input 25	B-26
Input 10	A-10	Input 26	B-27
Input 11	A-11	Input 27	B-28
Input 12	A-12	Input 28	B-29
Input 13	A-13	Input 29	B-30
Input 14	A-14	Input 30	B-31
Input 15	A-15	Input 31	B-32
+V1 DC power (input 0...15)	Power terminals 35, 37, 39, and 41 for Input 0...15. +V1 connected to terminals 35, 37, 39, and 41.		

**Table 2 - Wiring Connections for the 1794-IB32 and 1794-IB32K Modules (Continued)**  
(Use with a 1794-TB32 or 1794-TB32S Terminal Base)

Input <sup>(1)</sup>	Signal	Input	Signal
COM1 DC Return (input 0...15)	Common terminals 36, 38, 40, and 42 for Input 0...15. V1 Return connected to terminals 36, 38, 40, and 42.		
+V2 DC power (input 16...31)	Power terminals 43, 45, 47, and 49 for Input 16...31. +V2 connected to terminals 43, 45, 47, and 49.		
COM2 DC Return (input 16...31)	Common terminals 44, 46, 48, and 50 for Input 16...31. V2 Return connected to terminals 44, 46, 48, and 50.		

(1) 3-wire devices use signal, return, and supply. 2-wire devices use signal and supply.

## Configure Your Module

Configure your input module by setting bits in the configuration word (write word).

**Table 3 - Image Table Memory Map for 1794-IB8**

Dec	15	14	13	12	11	10	9	8	7	6	5	4	3	2	1	0	
Oct	17	16	15	14	13	12	11	10	7	6	5	4	3	2	1	0	
Read 1	Not used									17	16	15	14	13	12	11	10
Write 1	Not used													Input Filter 0...7			
Where:	I = Input																

**Table 4 - Image Table Memory Map for 1794-IB16**

Dec	15	14	13	12	11	10	9	8	7	6	5	4	3	2	1	0
Oct	17	16	15	14	13	12	11	10	7	6	5	4	3	2	1	0
Read 1	I15	I14	I13	I12	I11	I10	I9	I8	I7	I6	I5	I4	I3	I2	I1	I0
Read 2	C = Counter Input value of input 15															
Write 1	Not used		CF	CR							Input Filter 12...15			Input Filter 0...11		
Where:	I = Input C = Counter value for input 15 CF = Counter fast - where 1 = fast input (raw data), 0 standard input filtered data CR = Counter reset Note: C, CR, and CF not available when used with any series 1794-ASB or 1794-ASB2 remote I/O adapters.															

**Table 5 - Image Table Memory Map for 1794-IB32 and 1794-IB32K**

Dec	15	14	13	12	11	10	9	8	7	6	5	4	3	2	1	0
Oct	17	16	15	14	13	12	11	10	7	6	5	4	3	2	1	0
Read 1	I15	I14	I13	I12	I11	I10	I9	I8	I7	I6	I5	I4	I3	I2	I1	I0
Read 2	I31	I30	I29	I28	I27	I26	I25	I24	I23	I22	I21	I20	I19	I18	I17	I16
Write 1	Not used					Input Filter FT 0...31					Not used					
Where:	I = Input status FT = Input filter time															



## Set the Input Filter Time

To set the input filter time, set the associated bits in the output image table (complementary word) for the module.

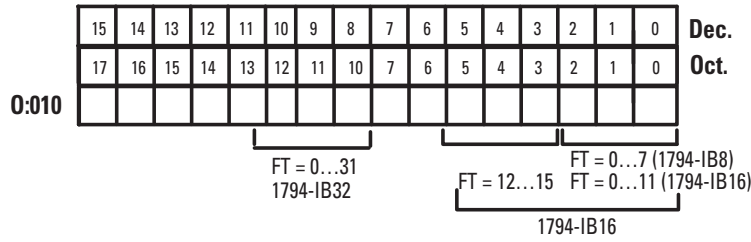

For example, to increase the Off-to-On filter time to 4 ms for all inputs at address rack 1, module group 0 (using 1794-IB32, 1794-IB32K as an example), set the following bits and program.

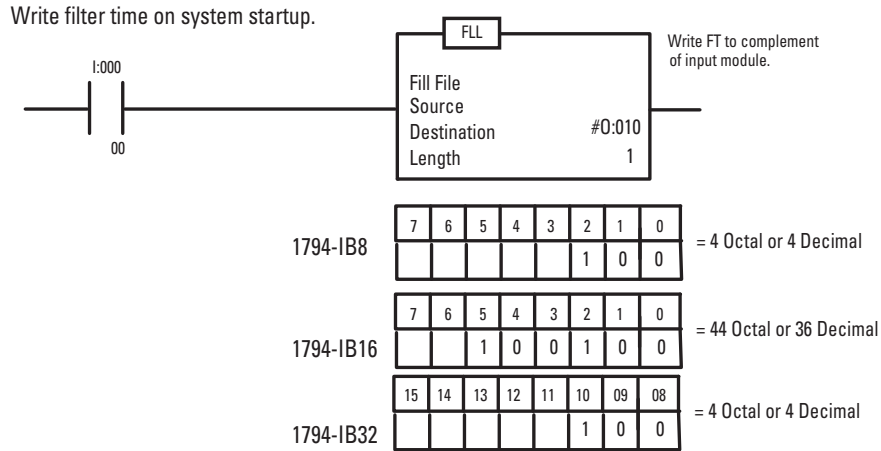

See [Table 6](#) for additional filter times.

**Table 6 - Input Filter Time**

Bits			Description	Selected Filter Time
<b>02</b>	<b>01</b>	<b>00</b>	<b>Filter Time for inputs 0...7 (1794-IB8)</b>	
<b>02</b>	<b>01</b>	<b>00</b>	<b>Filter Time for inputs 0...11 (1794-IB16)</b>	
<b>05</b>	<b>04</b>	<b>03</b>	<b>Filter Time for inputs 12...15 (1794-IB16)</b>	
<b>10</b>	<b>09</b>	<b>08</b>	<b>Filter Time for inputs 0...32 (1794-IB32, 1794-IB32K)</b>	
0	0	0	Filter Time 0 (Default)	0.25 ms
0	0	1	Filter Time 1	0.5 ms
0	1	0	Filter Time 2	1 ms
0	1	1	Filter Time 3	2 ms
1	0	1	Filter Time 4	4 ms
1	0	1	Filter Time 5	8 ms
1	1	0	Filter Time 6	16 ms
1	1	1	Filter Time 7	32 ms

## Specifications

### Specifications - 1794-IB8

Attribute	Value
Number of inputs	8, current, sinking
On-state voltage, min	10V DC
On-state voltage, nom	24V DC
On-state voltage, max	31.2V DC
On-state current, min	2.0 mA
On-state current, nom	8.0 mA
On-state current, max	12.0 mA
Off-state voltage, max	5.0V DC
Off-state current, max	1.5 mA
Nominal input impedance	4.6 kΩ
Isolation voltage	50V (continuous), Basic Insulation Type Type tested @ 850V DC for 60 s, between field side and system No isolation between individual channels
Flexbus current	20 mA @ 5V DC
Power dissipation, max	3.5 W @ 31.2V DC
Thermal dissipation, max	11.9 BTU/hr @ 31.2V DC

### Specifications - 1794-IB16

Attribute	Value
Number of inputs	16, current, sinking
On-state voltage, min	10V DC
On-state voltage, nom	24V DC
On-state voltage, max	31.2V DC
On-state current, min	2.0 mA
On-state current, nom	8.0 mA
On-state current, max	12.0 mA
Off-state voltage, max	5.0V DC
Off-state current, max	1.5 mA
Nominal input impedance	4.6 kΩ
Isolation voltage	50V (continuous), Basic Insulation Type Type tested @ 707V DC for 60 s, between field side and system No isolation between individual channels
Flexbus current	30 mA @ 5V DC
Power dissipation, max	6.1 W @ 31.2V DC
Thermal dissipation, max	20.8 BTU/hr @ 31.2V DC

### Specifications - 1794-IB32 and 1794-IB32K

Attribute	Value
Number of inputs	32, current, sinking
On-state voltage, min	19.2V DC
On-state voltage, nom	24V DC
On-state voltage, max	31.2V DC
On-state current, min	2.0 mA
On-state current, nom	4.1 mA
On-state current, max	6.0 mA
Off-state voltage, max	5.0V DC
Off-state current, max	1.5 mA
Nominal input impedance	22.2 kΩ
Isolation voltage	50V (continuous), Basic Insulation Type Type tested @ 2121V DC for 2 s, between field side and system No isolation between individual channels
Flexbus current	25 mA @ 5V DC
Power dissipation, max	6.0 W @ 31.2V DC
Thermal dissipation, max	20.47 BTU/hr @ 31.2V DC

## General Specifications

Attribute	1794-IB8	1794-IB16	1794-IB32, 1794-IB32K
Input filter time	See <a href="#">Table 6</a>		
Recommended terminal base unit	1794-TB3, 1794-TB3S, 1794-TB3K, 1794-TB3SK, 1794-TBKD, 1794-TB37DS		
Terminal base screw torque	Determined by the installed terminal base		
Keyswitch position	2		
Indicators (field side indication)	8 yellow status indicators	16 yellow status indicators	32 yellow status indicators
External DC power supply voltage, nom	24V DC		
External DC power supply voltage range	10...31.2V DC (includes 5% AC ripple)		19.2...31.2V DC (includes 5% AC ripple)
Wiring category <sup>(1) (2)</sup>	2 - on signal ports		
Wire size	Determined by the installed terminal base		
Dimensions, approx. (H x W x D) (with module installed)	94 x 94 x 69 mm (3.7 x 3.7 x 2.7 in.)		
Weight, approx.	71 g (2.50 oz.)	74 g (2.61 oz.)	79 g (2.79 oz.)
Enclosure type rating	None (open-style)		
North American temp code	T3C	T4A	T3C
IECEx temp code	T3	T4	-
UKEX/ATEX temp code	T3	T4	-

(1) Use this Conductor Category information for planning conductor routing. See the Industrial Automation Wiring and Grounding Guidelines, publication [1770-4.1](#).

(2) Use this Conductor Category information for planning conductor routing as described in the appropriate System Level Installation Manual.

## Environmental Specifications

Attribute	Value
Temperature, operating	IEC 60068-2-1 (Test Ad, Operating Cold), IEC 60068-2-2 (Test Bd, Operating Dry Heat), IEC 60068-2-14 (Test Nb, Operating Thermal Shock): -20...+55 °C (-4...+131 °F) - <b>1794-IB8, 1794-IB16</b> 0...55 °C (32...131 °F) - <b>1794-IB32, 1794-IB32K</b>
Temperature, surrounding air, max	55 °C (131 °F)
Temperature, nonoperating	IEC 60068-2-1 (Test Ab, Unpackaged Nonoperating Cold), IEC 60068-2-2 (Test Bb, Unpackaged Nonoperating Dry Heat), IEC 60068-2-14 (Test Na, Unpackaged Nonoperating Thermal Shock): -40...+85 °C (-40...+185 °F)
Relative humidity	IEC 60068-2-30 (Test Db, Unpackaged Damp Heat): 5...95% noncondensing
Vibration	IEC60068-2-6 (Test Fc, Operating): 5 g @ 10...500 Hz
Shock, operating	IEC60068-2-27 (Test Ea, Unpackaged shock): 30 g
Shock, nonoperating	IEC60068-2-27 (Test Ea, Unpackaged shock): 50 g
Emissions	IEC 61000-6-4
ESD immunity	IEC 61000-4-2: 6 kV contact discharges 8 kV air discharges
Radiated RF immunity	IEC 61000-4-3: 10V/m with 1 kHz sine-wave 80% AM from 80...6000 MHz
EFT/B immunity	IEC 61000-4-4: ±2 kV @ 5 kHz on power ports ±2 kV @ 5 kHz on signal ports
Surge transient immunity	IEC 61000-4-5: ±1 kV line-line(DM) and ±2 kV line-earth(CM) on signal ports
Conducted RF immunity	IEC 61000-4-6: 10V rms with 1 kHz sine-wave 80% AM from 150 kHz...80 MHz

**Certifications**

Certifications (when product is marked) <sup>(1)</sup>	Value
c-UL-us	<p><b>For 1794-IB8, 1794-IB16</b> UL Listed Industrial Control Equipment, certified for US and Canada. See UL File E65584. UL Listed for Class I, Division 2 Group A, B, C, D Hazardous Locations, certified for U.S. and Canada. See UL File E194810.</p> <p><b>For 1794-IB32, 1794-IB32K</b> UL Listed Industrial Control Equipment, certified for US and Canada. See UL File E322657. UL Listed for Class I, Division 2, Group A, B, C, D Hazardous Locations, certified for US and Canada. See UL File E334470.</p>
UK and CE	<p>UK Statutory Instrument 2016 No. 1091 and European Union 2014/30/EU EMC Directive, compliant with: EN 61326-1; Meas./Control/Lab., Industrial Requirements EN 61000-6-2; Industrial Immunity EN 61131-2; Programmable Controllers EN 61000-6-4; Industrial Emissions</p> <p>UK Statutory Instrument 2012 No. 3032 and European Union 2011/65/EU RoHS, compliant with: EN 63000; Technical documentation</p>
Ex	<p>UK Statutory Instrument 2016 No. 1107 and European Union 2014/34/EU ATEX Directive, compliant with: EN IEC 60079-0; General Requirements EN IEC 60079-7; Explosive Atmospheres, Protection "e" II 3 G Ex ec IIC T4 Gc - <b>1794-IB16</b> II 3 G Ex ec IIC T3 Gc - <b>1794-IB8</b> DEMKO 14 ATEX 1342501X UL22UKEX2378X</p>
IECEX	<p>IECEX System, compliant with: IEC 60079-0; General Requirements IEC 60079-7; Explosive Atmospheres, Protection "e" Ex ec IIC T4 Gc - <b>1794-IB16</b> Ex ec IIC T3 Gc - <b>1794-IB8</b> IECEX UL 14.0066X</p>
TÜV	<p><b>For 1794-IB16 only</b> TÜV Certified for Functional Safety: Up to and including SIL 2</p>
RCM	<p>Australian Radiocommunications Act, compliant with: EN 61000-6-4; Industrial Emissions</p>
KC	<p>Korean Registration of Broadcasting and Communications Equipment, compliant with: Article 58-2 of Radio Waves Act, Clause 3</p>
Morocco	<p>Arrêté ministériel n° 6404-15 du 29 ramadan 1436</p>
CCC	<p>CNCA-C23-01 强制性产品认证实施规则 防爆电气 CNCA-C23-01 CCC Implementation Rule Explosion-Proof Electrical Products 202012230911829</p>

(1) See the Product Certification link at [rok.auto/certifications](http://rok.auto/certifications) for Declarations of Conformity, Certificates, and other certification details.

**Figure 4 - Derating Curve for 1794-IB16**

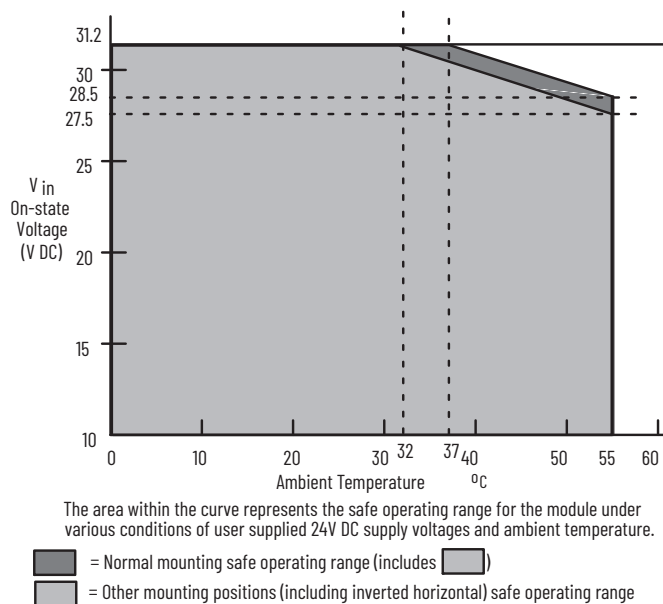

Voltage, Max	Temperature, Max		Voltage, Max	Temperature, Max	
	Normal	Other		Normal	Other
31.2	37	32	29.0	51	45
30.5	41	36	28.5	55	48
30.0	45	39	28.0		51
29.5	48	42	27.5		55

**Normal Mounting - Horizontal**

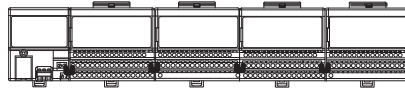

**Other Mounting - (including Vertical and Inverted Horizontal Mounting)**

**Vertical mounting**

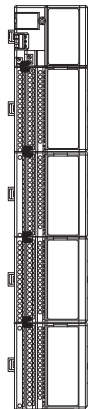

**Inverted horizontal mounting**

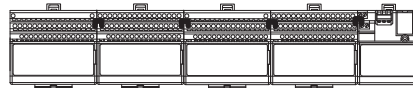

**Additional Resources**

For more information on the products that are described in this publication, use these resources. You can view or download publications at [rok.auto/literature](http://rok.auto/literature).

Resource	Description
FLEX I/O and FLEX I/O-XT Selection Guide, publication <a href="#">1794-SG002</a>	Provides specifications for selecting FLEX I/O and FLEX I/O-XT™ products.
Industrial Automation Wiring and Grounding Guidelines, publication <a href="#">1770-4.1</a>	Provides general guidelines for installing a Rockwell Automation industrial system.
Product Certifications website, <a href="http://rok.auto/certifications">rok.auto/certifications</a>	Provides declarations of conformity, certificates, and other certification details.

## Rockwell Automation Support

Use these resources to access support information.

<b>Technical Support Center</b>	Find help with how-to videos, FAQs, chat, user forums, Knowledgebase, and product notification updates.	<a href="http://rok.auto/support">rok.auto/support</a>
<b>Local Technical Support Phone Numbers</b>	Locate the telephone number for your country.	<a href="http://rok.auto/phonesupport">rok.auto/phonesupport</a>
<b>Technical Documentation Center</b>	Quickly access and download technical specifications, installation instructions, and user manuals.	<a href="http://rok.auto/techdocs">rok.auto/techdocs</a>
<b>Literature Library</b>	Find installation instructions, manuals, brochures, and technical data publications.	<a href="http://rok.auto/literature">rok.auto/literature</a>
<b>Product Compatibility and Download Center (PCDC)</b>	Download firmware, associated files (such as AOP, EDS, and DTM), and access product release notes.	<a href="http://rok.auto/pcdc">rok.auto/pcdc</a>

## Documentation Feedback

Your comments help us serve your documentation needs better. If you have any suggestions on how to improve our content, complete the form at [rok.auto/docfeedback](http://rok.auto/docfeedback).





## Waste Electrical and Electronic Equipment (WEEE)



At the end of life, this equipment should be collected separately from any unsorted municipal waste.

Rockwell Automation maintains current product environmental compliance information on its website at [rok.auto/pec](http://rok.auto/pec).

Rockwell Otomasyon Ticaret A.Ş. Kar Plaza İş Merkezi E Blok Kat:6 34752 İçerenköy, İstanbul, Tel: +90 (216) 5698400 EEE Yönetmeliğine Uygundur

Connect with us.    

**rockwellautomation.com** — expanding **human possibility**<sup>®</sup>

AMERICAS: Rockwell Automation, 1201 South Second Street, Milwaukee, WI 53204-2496 USA, Tel: (1) 414.382.2000

EUROPE/MIDDLE EAST/AFRICA: Rockwell Automation NV, Pegasus Park, De Kleetlaan 12a, 1831 Diegem, Belgium, Tel: (32) 2663 0600

ASIA PACIFIC: Rockwell Automation SEA Pte Ltd, 2 Corporation Road, #04-05, Main Lobby, Corporation Place, Singapore 618494, Tel: (65) 6510 6608

UNITED KINGDOM: Rockwell Automation Ltd., Pitfield, Kiln Farm, Milton Keynes, MK11 3DR, United Kingdom, Tel: (44)(1908) 838-800

Allen-Bradley, ControlLogix, expanding human possibility, FactoryTalk, FLEX, FLEX I/O-XT, Logix 5000, Rockwell Automation, RSLogix 5000, Studio 5000 Logix Designer, and TechConnect are trademarks of Rockwell Automation, Inc.

ControlNet, DeviceNet and EtherNet/IP are trademarks of ODVA, Inc.

Trademarks not belonging to Rockwell Automation are property of their respective companies.

Publication 1794-IN0931-EN-P - March 2024 | Supersedes Publication 1794-IN093H-EN-P - July 2023

Copyright © 2024 Rockwell Automation, Inc. All rights reserved.